

BT-M6Z02-RF

230V/24V



USER GUIDE	GB
<i>MASTER 6 ZONES RF</i>	2-10
GEBRUIKERSHANDLEIDING	NL
<i>MASTER 6 ZONES RF</i>	11-20
GUIDE UTILISATEUR	FR
<i>MASTER 6 ZONES RF</i>	21-29
BEDIENUNGSANLEITUNG	DE
<i>FUNK-REGELVERTEILER MASTER 6 ZONEN</i>	30-39
GUIDA UTENTE	IT
<i>MASTER RF A 6 ZONE</i>	40-49
GUÍA DEL USUARIO	ES
<i>DISPOSITIVO MAESTRO DE 6 ZONAS RF</i>	50-59

1 USER GUIDE

The Connecting box BT-M6Z02-RF is especially designed to control your Under Floor Heating and Cooling system.

It can handle Normally Closed or Normally Opened actuators.

Connecting box has by conception 6 outputs actuators and this number can be extended to 10 or 12 with an extension.

BT-M6Z02-RF works with thermostats linked in RF; it can have up to 12 thermostats linked to it and handle 12 independent regulations in parallel.

It works with all thermostats of BT02 RF and BT03 RF range.

Special features of BT-M6Z02-RF are:

- pump or boiler output (wired or wireless with BT-WR02-RF or BT-WR02 FC RF)
- Humidity management (via BT-D02-RF RH and BT-DP02-RF RH)
- Heat and Cool signal input management (via BT-HCM02-RF)
- Dehumidifier output (via BT-HCM02-RF)
- Connection with BT-CT02-RF central unit

2 TECHNICAL CHARACTERISTICS

	BT-M6Z02-RF 230V	BT-M6Z02-RF 24V
Operating Temperature	0°C to 50°C	
Regulation characteristics	Proportional Integral regulation or Hysteresis regulation. Regulation is defined by thermostat linked to channel (see thermostat leaflet)	
Supply Voltage	230VAC +- 10% 50Hz	24Vac +- 10% 50Hz
Outputs: Pump or accessories Actuators	Relay => 5A / 250VAC (Free contact) Relay => 5A / 230 VAC (L, N) For easy installation we recommend a maximum of 4 actuators by zones.	Relay => 5A / 250Vac (free contact) Triac => 3A / 24Vac Total number of actuators is limited by transformer (60VA) and fuse (2,5A) and power of actuators.
Radio Frequency	868, 3 MHz, <10mW. Range of approximately 180 meters in open space. Range of approximately 50 meters in residential environment.	
CE Directives Your product has been designed in conformity with the European Directives.	R&TTE 2014/53/EU LVD 2014/35/EU EMC 2014/30/EU RoHS 2011/65/EU Directive on General Products Safety 2001/95/EC	
Protection	IP 30	
Compatibility	With BT S4Z02 RF: 10 Zones => 1 Master 6 + 1 Slave 4 zones With BT S6Z02 RF: 12 Zones => 1 Master 6 + 1 Slave 6 zones BT-HCM02 RF BT-WR02-RF, BT-WR02 FC RF BT-PR02-RF BT-FR02-RF BT-CT02-RF Repeater RF BT-A02 RF BT-D02 RF, BT-D02 RH RF BT-DP02 RF, BT-DP02 RH RF BT-D03 RF	

3 User interface

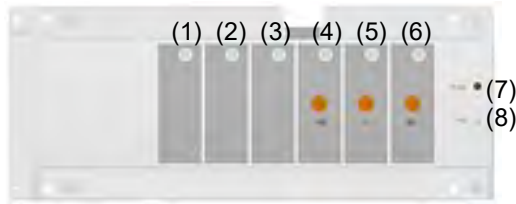

3.A. LED color meanings

On BT-M6Z02-RF there are one bicolor Led per zone (1) to (6) and 2 additional status Leds.

In normal working mode:

- (1) To (6):
 - o **Red fix:** Heating or Cooling demand indicator (Water circulation on this zone)
 - o **Green flash:** RF signal received from the thermostat assigned to this zone
 - o **Red blinking:** RF alarm, the communication between thermostat and the BT-M6Z02-RF has been lost (in this case check batteries on this thermostat)
 - o **Red blinking on all zones:** check the RF antenna connection
- (7): Pump indicator
 - o **Green** when pump output is active
- (8): Heat and Cool indicator
 - o **Green** when cooling
 - o **Red** when Heating
 - o **Red or Green** blinking: RF alarm between the BT-M6Z02 RF and any device other than a thermostat

In RF linking mode Leds indicators (1) to (6) have a different meaning, Refer to 6.

3.B. Buttons

On BT-M6Z02-RF, there are 3 buttons "<", "OK" and ">".

They are used to:

- link elements to BT-M6Z02-RF: refer to section 7
- do a factory reset (reset all configuration and all RF links) : refer to section 7

3.C. DIP swith configuration

When you unscrew the front face of BT-M6Z02-RF, you have access to 4 switches used for advanced configuration:



By default position is OFF for the 4 switches

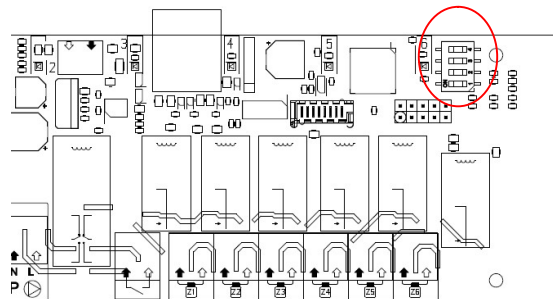

Switch 1: Local / global Pump configuration (pump output AND remote pump device)

ON (global): BT-M6Z02-RF activates its pump if there is a heat or cool demand in the system

OFF (local): BT-M6Z02-RF activates its pump only if there is a demand on the BT-M6Z02-RF

Switch 2: NO / NC configuration

ON (NO): Outputs (actuators) are Normally Open

OFF (NC): Outputs (actuators) are Normally Closed

Switch 3: Pump Exercise configuration

ON: Once a week, pump output is activated.

OFF: No action on pump output

Switch 4: No action

4 WIRING ASSEMBLY DIAGRAM

4.1 WIRING ASSEMBLY DIAGRAM 230V

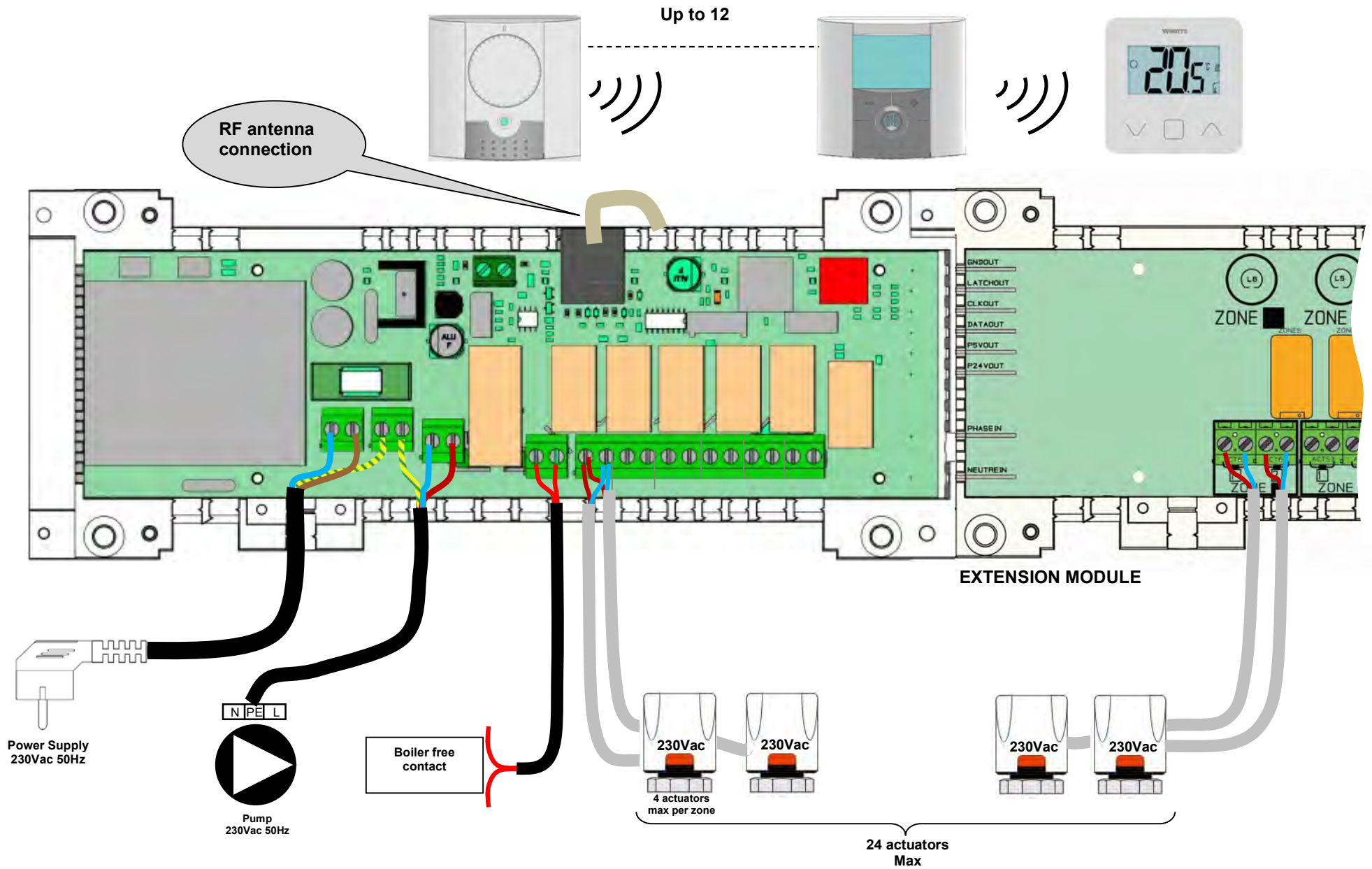

4.2 WIRING ASSEMBLY DIAGRAM 24V

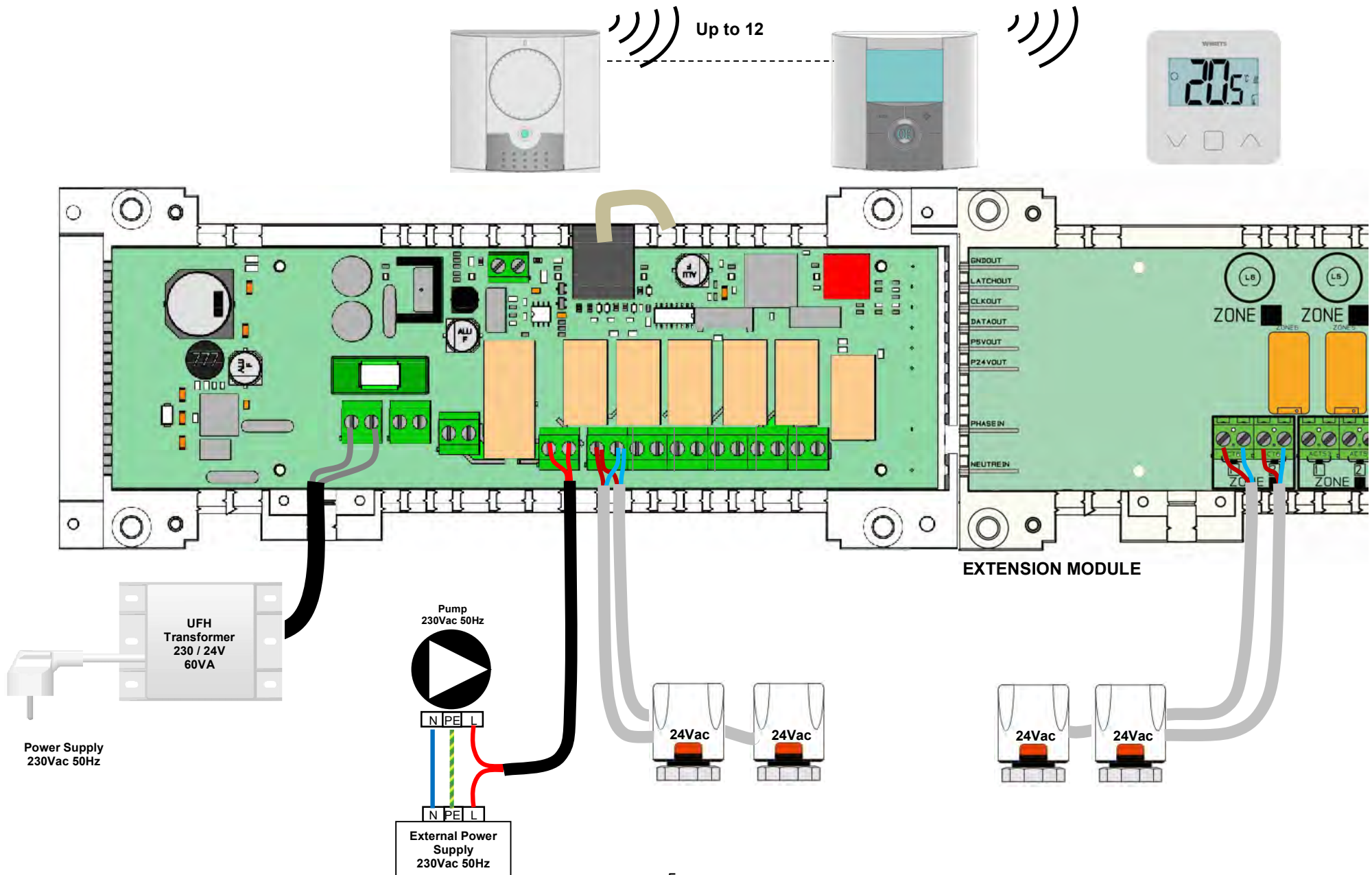

5 HOW TO INSTALL CORRECTLY YOUR RF SYSTEM



Please respect the mounting to optimize sensibility and avoid any dysfunctionment

Antenna must placed:

- outside the metallic box
- in vertical position
- and at least at 50cm of metallic parts

If you have several antenna (several BT-M6Z02-RF / BT-HCM02-RF in the same place), they must be placed at minimum 80cm of each other.

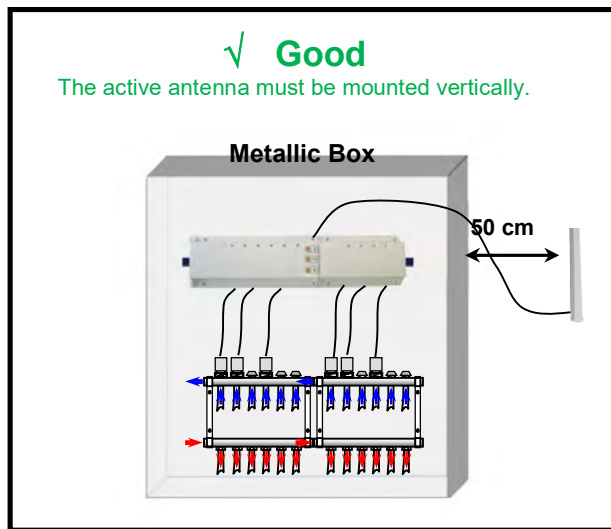

6 SYSTEM POSSIBILITIES:

Please refer to System configuration manual (www.wattselectronics.com), for more information on the different possibilities.

We distinguish 2 types of installation, if you have a BT-CT02-RF in your installation jump to 6.B

6.A. Installation without Touchscreen BT-CT02-RF

In this installation, we have 2 subcases:

- 1- Installation "Standalone": Typical installations:
 - a. Only one BT-M6Z02-RF
 - b. Several BT-M6Z02-RF with local pump management
- 2- Installation "Centralized management": In this case, there are several BT-M6Z02-RF that needs to communicate together to drive correctly pump handle Heat/Cool signal.
 - a. Several BT-M6Z02-RF with global pump management
 - b. At least several BT-M6Z02-RF and one BT-HCM02-RF

6.A.1 Standalone Installation Exemple of a "Standalone Installation"

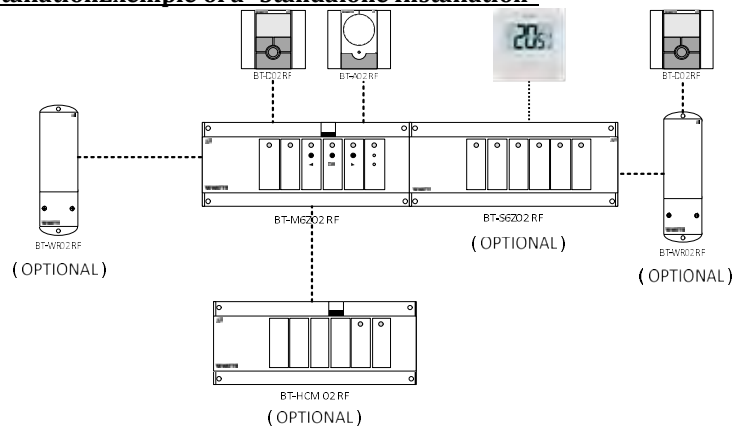

----- RF Links to do

All those elements needs to be linked together, the RF link procedure can be done in this order:

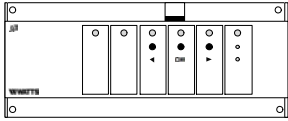
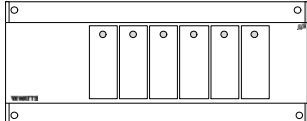
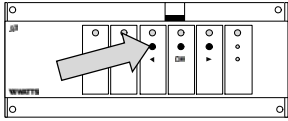
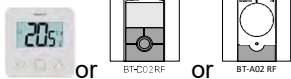
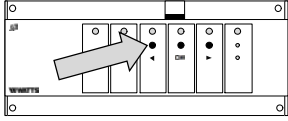
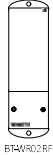
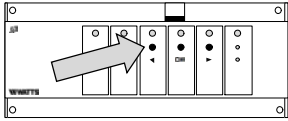
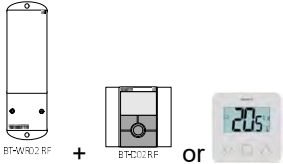
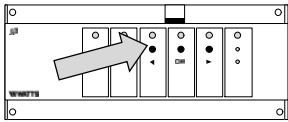
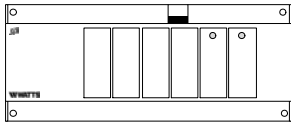
Element 1 to link	Element 2 to link	Comments
<p align="center">BT-M6Z02-RF</p>  <p align="center">BT-M6Z02 RF</p>	<p align="center">BT-S4Z / BT-S6Z</p>  <p align="center">BT-S6Z02 RF</p>	<p>No need to link them, just assemble S4Z or S6Z with BT-M6Z02-RF (both products OFF powered) and you can select the additional zones</p>
<p align="center">BT-M6Z02-RF</p>  <p align="center">BT-M6Z02 RF</p> <p>Press OK for 5 seconds, first channel LED must blink.</p> <p>Choose the channels with < and > and select/deselect the zone with OK.</p> <p>When a zone is selected it turns Red.</p> <p>Note: To exit, press OK for 5 seconds.</p>	<p align="center">BT-D03 RF / BT-D(P)02-RF / BT-A02-RF</p>  <p>Thermostats : Put product in RF Link mode (refer to correspondant instruction manual)</p>	<p>If link is done, the leds of channels selected on the BT-M6Z02 RF must turn Green and the thermostats must exit the RF link mode.</p>
<p align="center">BT-M6Z02-RF</p>  <p align="center">BT-M6Z02 RF</p> <p>Press < for 5 seconds, all channel leds must blink Green. Product is waiting for link.</p> <p>Note: To exit, press < for 5 seconds.</p>	<p align="center">BT-WR02-RF</p>  <p>Put product in RF Link mode.</p>	<p>In this configuration, BT-WR-WR02-RF is used as on remote pump device or boiler: if there is a demand on the BT-M6Z02-RF, the device will command the output.</p> <p>When link is done BT-M6Z02-RF And BT-WR02-RF return to normal mode</p> <p>REMARK: instead of BT-WR02-RF, you can also use BT-FR02-RF and BT-PR02-RF</p>
<p align="center">BT-M6Z02-RF</p>  <p align="center">BT-M6Z02 RF</p> <p>Press < for 5 seconds, all channel leds must blink Green. Product is waiting for link.</p> <p>Note: To exit, press < for 5 seconds.</p>	<p align="center">BT-WR02-RF + BT-D02-RF/ BT-D03 RF</p>  <p>BT-WR02-RF must have been first linked with the thermostat.</p> <p>Put BT-WR02-RF in RF Link mode.</p>	<p>In this configuration, BT-WR-WR02-RF is used as additional zone.</p> <p>When link is done BT-M6Z02-RF And BT-WR02-RF return to normal mode</p> <p>REMARK 1: instead of BT-WR02-RF, you can also use BT-FR02-RF and BT-PR02-RF</p> <p>REMARK 2: this configuration is only possible in Heating installation (no cooling)</p>
<p align="center">BT-M6Z02-RF</p>  <p align="center">BT-M6Z02 RF</p> <p>Press < for 5 seconds, all channel leds must blink Green. Product is waiting for link.</p> <p>Note: To exit, press < for 5 seconds.</p>	<p align="center">BT-HCM02-RF</p>  <p align="center">BT-HCM02 RF</p> <p>Put product in RF Link mode.</p>	<p>When link is done BT-M6Z02-RF And BT-HCM02-RF return to normal mode at the same time.</p>

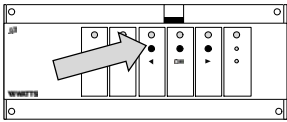
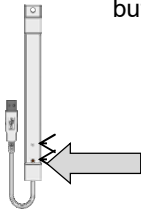
<p style="text-align: center;">BT-M6Z02-RF</p>  <p style="text-align: center;">BT-M6Z02 RF</p> <p>Press < for 5 seconds, all channel leds must blink Green. Product is waiting for link. Note: To exit, press < for 5 seconds</p>	<p>Put the RF repeater in RF Link mode (press 3 s on the button)</p> 	<p>When link is done, BT-M6Z02-RF returns to normal mode and the led on the repeater becomes green fix.</p>
---	--	---

6.A.2 Centralized Installation

In this configuration, one BT-M6Z02-RF - called "Main" BT-M6Z02-RF - will centralize the information of the other BT-M6Z02-RF – called "Sub" BT-M6Z02-RF.

Its role is

- to propagate Heat and Cool signal to the system
- to handle the boiler / global pump for the whole system.

If there is a BT-HCM02-RF in the installation, it MUST be linked to "Main" BT-M6Z02-RF.

Exemple of a "Centralized Installation"

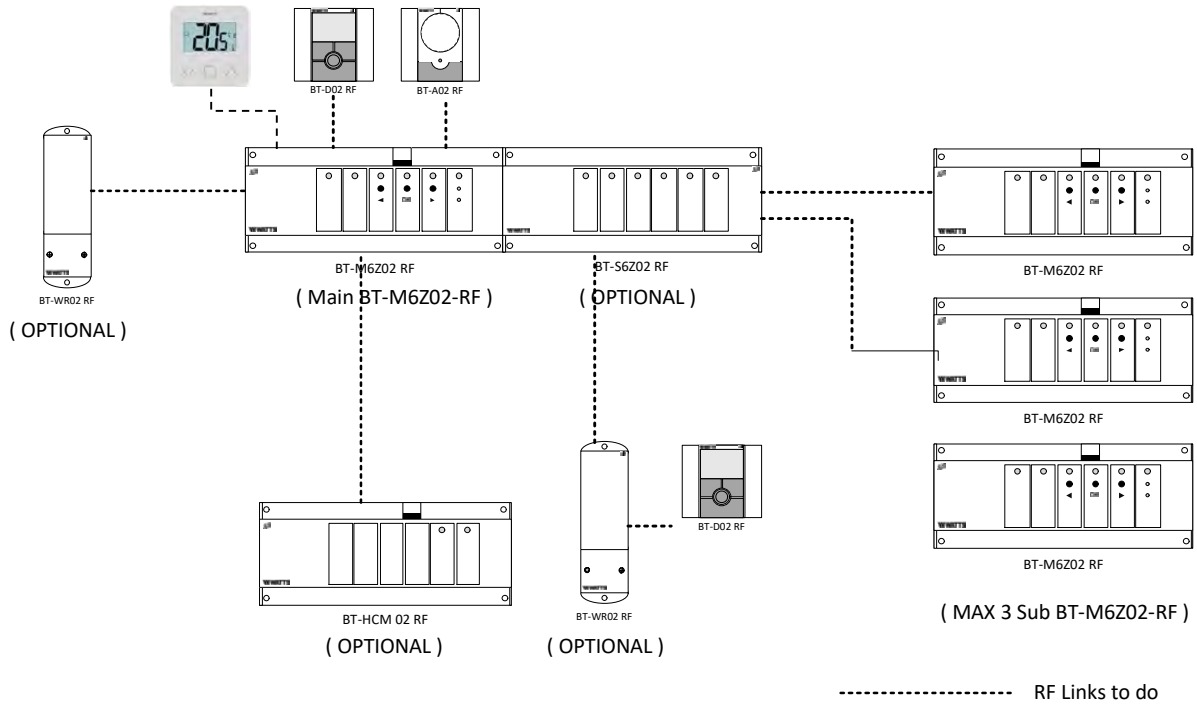

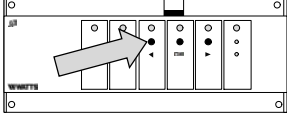
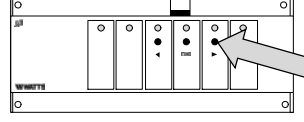
Element 1 to link	Element 2 to link	Comments
<p>Do the RF Link procedure as in Standalone version then proceed with the RF link of all BT-M6Z02-RF</p>		
<p style="text-align: center;">« Main » BT-M6Z02-RF</p>  <p style="text-align: center;">BT-M6Z02 RF</p> <p>Press < for 5 seconds, all channel leds must blink Green. Product is waiting for link. Note: To exit, press < for 5 seconds.</p>	<p style="text-align: center;">« Sub » BT-M6Z02-RF</p>  <p style="text-align: center;">BT-M6Z02 RF</p> <p>Press > for 5 seconds, all channel leds must blink Red. Product is waiting for link. Note: To exit, press > for 5 seconds.</p>	<p>When link is done, the two BT-M6Z02-RF return to normal mode.</p>

6.B. Installation with Touchscreen BT-CT02-RF

If there is a Touchscreen BT-CT02-RF in the installation, everything is centralized by the Touchscreen.

Exemple of an “Centralized Installation”

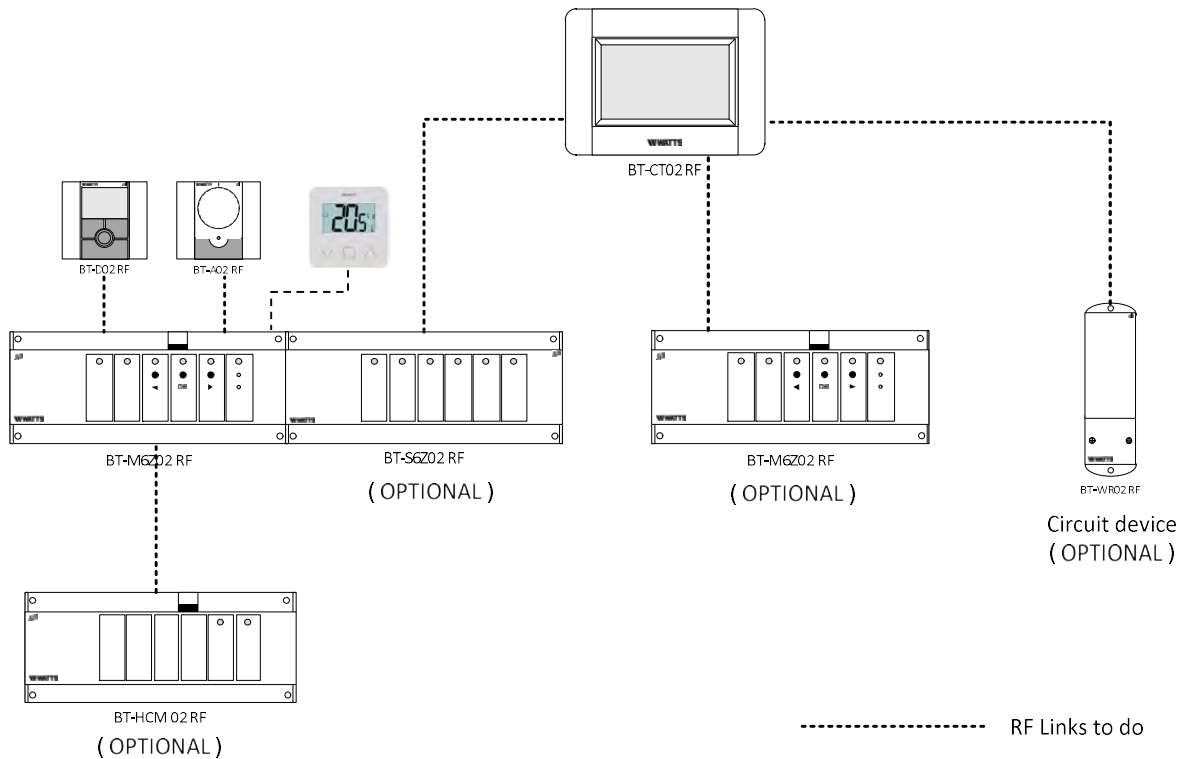

In this configuration, proceed with the RF link in this order:

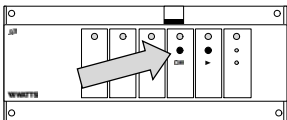
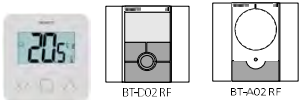
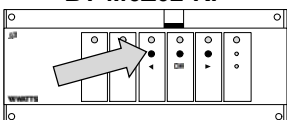
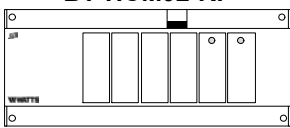
Element 1 to link	Element 2 to link	Comments
<p style="text-align: center;">BT-M6Z02-RF</p>  <p style="text-align: center;">BT-M6Z02 RF</p> <p>Press OK for 5 seconds, first channel LED must blink. Choose the channels with < and > and select/deselect the zone with OK. When a zone is selected it turns Red. Note: To exit, press OK for 5 seconds.</p>	<p style="text-align: center;">BT-D03 RF / BT-D(P)02-RF / BT-A02-RF</p>  <p>Thermostats : Put product in RF Link mode (refer to correspondant instruction manual)</p>	<p>If link is done, the leds of channels selected on the BT-M6Z02 RF must turn Green and the thermostats must exit the link mode.</p>
<p style="text-align: center;">BT-M6Z02-RF</p>  <p style="text-align: center;">BT-M6Z02 RF</p> <p>Press < for 5 seconds, all channel leds must blink Green. Product is waiting for link. Note: To exit, press < for 5 seconds.</p>	<p style="text-align: center;">BT-HCM02-RF</p>  <p style="text-align: center;">BT-HCM02 RF</p> <p>Put product in RF Link mode.</p>	<p>When link is done BT-M6Z02-RF And BT-HCM02-RF return to normal mode.</p> <p>REMARK: only one BT-HCM02-RF in the installation</p>

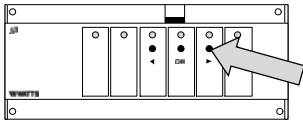
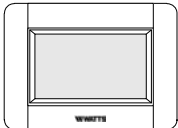
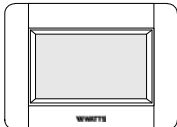
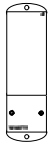
<p style="text-align: center;">BT-M6Z02-RF</p>  <p style="text-align: center;">BT-M6Z02 RF</p> <p>Press > for 5 seconds, all channel leds must blink Red. Product is waiting for link. Note: To exit, press > for 5 seconds.</p>	<p style="text-align: center;">BT-CT02-RF</p>  <p style="text-align: center;">BT-CT02 RF</p> <p>Link as a normal zone</p>	
<p style="text-align: center;">BT-CT02-RF</p>  <p style="text-align: center;">BT-CT02 RF</p> <p>Link « Circuit » device</p>	<p style="text-align: center;">BT-WR02-RF</p>  <p style="text-align: center;">BT-WR02 RF</p> <p>Put product in RF Link mode.</p>	<p>In this configuration, BT-WR-WR02-RF is used as hydraulic circuit device: Refer to the instruction manual of BT-CT02-RF for further explanation.</p>

Be careful! Link BT-M6Z02-RF to BT-CT02-RF, once ALL thermostats to BT-M6Z02-RF have been linked.

7 SPECIAL FUNCTIONS

Humidity management

This feature is available on thermostats that have Humidity sensor (BT-D02RF RH and BT-DP02RF RH).

Please refer to thermostat instruction manual to correctly set the parameters.

- If there is a humidity default (dew point or humidity threshold), then cooling on the zone is stopped (stops flow in the zone).
- If in the installation there is a BT-HCM02-RF and dehumidifier is active then if there is humidity default, dehumidifier is active

Pump Delay (not configurable)

To avoid pump damage and noise in hydraulic circuit (Water flow in the pipe) the start-up of the pump will be delayed for 1 minute after a heating demand from the zone thermostats. This delay should allow the actuator to be completely opened before the activation of the pump.

Valve exercise (not configurable)

To prevent the valves from seizing, each valve is automatically activated 2 minutes per week.

Factory settings function:

Use this function to erase all configurations, RF links and restore factory settings.

In 'Run mode', press in the same time during 5 seconds the 2 keys (◀) and (▶).

Then the product has been resetted.

1 GEBRUIKERSHANDLEIDING

Aansluitdoos BT-M6Z02-RF is speciaal ontworpen voor de bediening van uw vloerverwarmings-/koelingssysteem.

Zij kan met normaal gesloten of normaal geopende afsluiters werken.

De aansluitdoos heeft normaal gesproken 6 uitgangen, maar kan worden uitgebreid tot 10 of 12.

BT-M6Z02-RF werkt met thermostaten die d.m.v. RF gekoppeld zijn; er kunnen tot en met 12 thermostaten aan worden gekoppeld en zij kan 12 onafhankelijke regelingen parallel verwerken.

Zij werkt met alle thermostaten uit de BT02 RF BT03 RF reeks.

Bijzondere kenmerken van BT-M6Z02-RF zijn:

- Pomp- of boileruitgang (bedraad of draadloos met BT-WR02-RF)
- Vochtigheidsbeheer (via BT-D02-RF RH en BT-DP02-RF RH)
- Beheer ingang van signaal voor koelen en verwarmen (via BT-HCM02-RF)
- Uitgang ontvochtiger (via BT-HCM02-RF)
- Aansluiting op BT-CT02-RF centrale unit

2 TECHNISCHE SPECIFICATIES

	BT-M6Z02-RF 230V	BT-M6Z02-RF 24V
Gebruikstemperatuur	0°C tot 50°C	
Regelkarakteristiek	Proportioneel integrerende regeling of hystereseregeling. De regeling wordt bepaald door de op het kanaal aangesloten thermostaat (zie de handleiding van de thermostaat)	
Voedingsspanning	230VAC +- 10% 50Hz	24Vac +- 10% 50Hz
Uitgangen: Pompen of toebehoren Afsluiters	Relais => 5A / 250 VAC (vrij contact) Relais => 5 A / 230 VAC (L, N) Om de installatie te vergemakkelijken adviseren we maximaal 4 afsluiters per zone te gebruiken.	Relais => 5 A / 250 Vac (vrij contact) Triac => 3 A / 24 Vac Het totale aantal afsluiters is beperkt door de transformator (60 VA) en de zekering (2,5 A) en het vermogen dat de afsluiters vragen.
Radiofrequentie	868,3 MHz, <10 mW. Bereik circa 180 meter zonder obstakels. Bereik circa 50 meters in een woonomgeving.	
CE-richtlijnen Dit product voldoet aan de Europese Richtlijnen.	Richtlijn 2001/95/EG inzake algemene productveiligheid Laagspanningsrichtlijn 2014/35/EU Richtlijn 2014/53/EU inzake radioapparatuur RoHS-richtlijn 2011/65/EU EMC-richtlijn 2014/30/EU	
Beschermingsgraad	IP30	
Compatibiliteit	Met BT S4Z02 RF: 10 zones => 1x Master met 6 + 1x Slave met 4 zones Met BT S6Z02 RF: 12 zones => 1x Master met 6 + 1x Slave met 6 zones Signaalversterker RF BT-HCM02 RF BT-WR02-RF, BT-WR02 FC RF BT-PR02-RF BT-FR02-RF BT-CT02-RF BT-A02 RF BT-D02 RF, BT-D02 RH RF BT-DP02 RF, BT-DP02 RH RF BT-D03 RF	

3 Gebruikersinterface



3.A. Betekenis van LED-kleur

De BT-M6Z02-RF heeft één tweekleurige led per zone (1) tot en met (6) en 2 extra status-leds.

Tijdens normaal bedrijf:

- (1) tot en met (6):
 - o **Licht rood op:** Indicatie vraag naar warmte of koeling (water circuleert naar deze zone)
 - o **Knippert fel groen:** RF-sigitaal ontvangen van de thermostaat voor deze zone.
 - o **Knippert rood:** RF-alarm, communicatie tussen thermostaat en BT-M6Z02-RF is verbroken (controleer in dit geval de batterijen in deze thermostaat)
 - o **Knippert rood in alle zones:** controleer aansluiting RF-antenne
- (7): Indicator pomp
 - o **Groen** als uitgang van pomp actief is
- (8): Indicator verwarmen en koelen
 - o **Groen** bij koelen
 - o **Rood** bij verwarmen
 - o **Rood of groen knipperend:** RF-alarm tussen de BT-M6Z02 RF en een ander apparaat dan een thermostaat

Tijdens het maken van de RF-verbinding hebben leds (1) tot en met (6) een andere betekenis, zie 6.

3.B. Knoppen

De BT-M6Z02-RF heeft 3 knoppen: "<", "OK" en ">".

Zij dienen om:

- elementen met BT-M6Z02-RF te verbinden: zie hoofdstuk 7
- de fabrieksinstellingen te herstellen (alle configuraties en RF-verbindingen worden gereset) : zie hoofdstuk 7

3.C. Configuratie met DIP-schakelaars

Als u de voorplaat van de BT-M6Z02-RF los schroeft heeft u toegang tot 4 schakelaars voor geavanceerde configuratie:

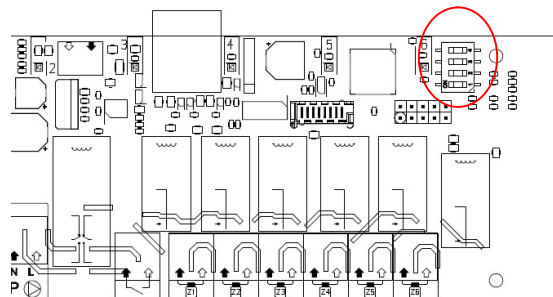

Voor de 4 schakelaars is OFF de standaardpositie

Schakelaar 1: Lokale / algemene pompconfiguratie (pompuitgang EN bediening pomp of afstand)

AAN (algemeen): BT-M6Z02-RF activeert pomp als het systeem om verwarming of koeling vraagt

UIT (lokaal): BT-M6Z02-RF activeert pomp alleen als er vraag is op de BT-M6Z02-RF

Schakelaar 2: NO / NC configuratie

AAN (NO): Uitgangen (afsluiters) zijn Normaal Open

UIT (NC): Uitgangen (afsluiters) zijn Normaal Gesloten

Schakelaar 3: Configuratie voor testen pomp

AAN: Eén keer per week wordt pompuitgang geactiveerd

UIT: Geen actie op pompuitgang

Schakelaar 4: Geen actie

4 AANSLUITSCHEMA

4.1 AANSLUITSCHEMA 230V

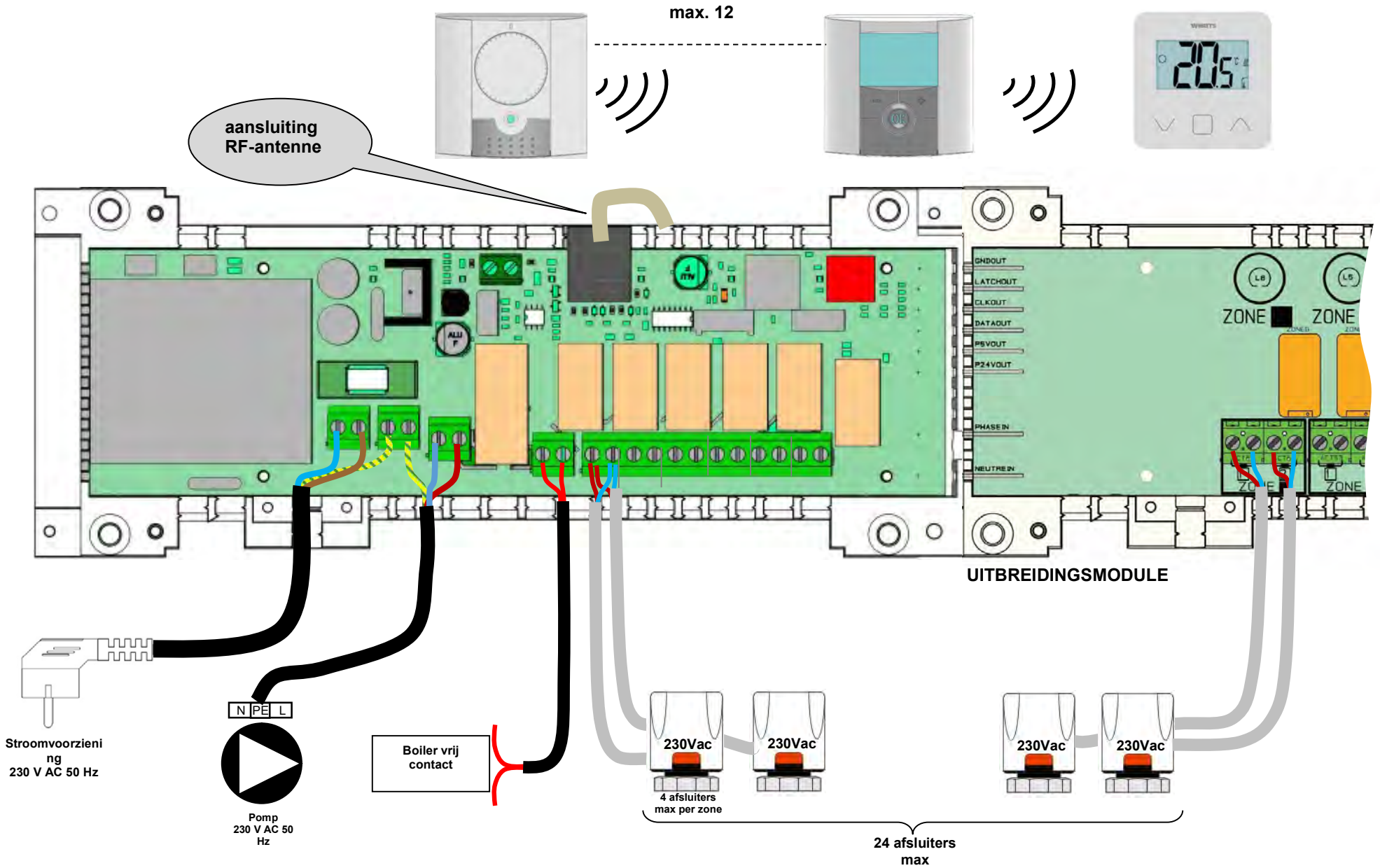

4.2 AANSLUITSCHEMA 24V

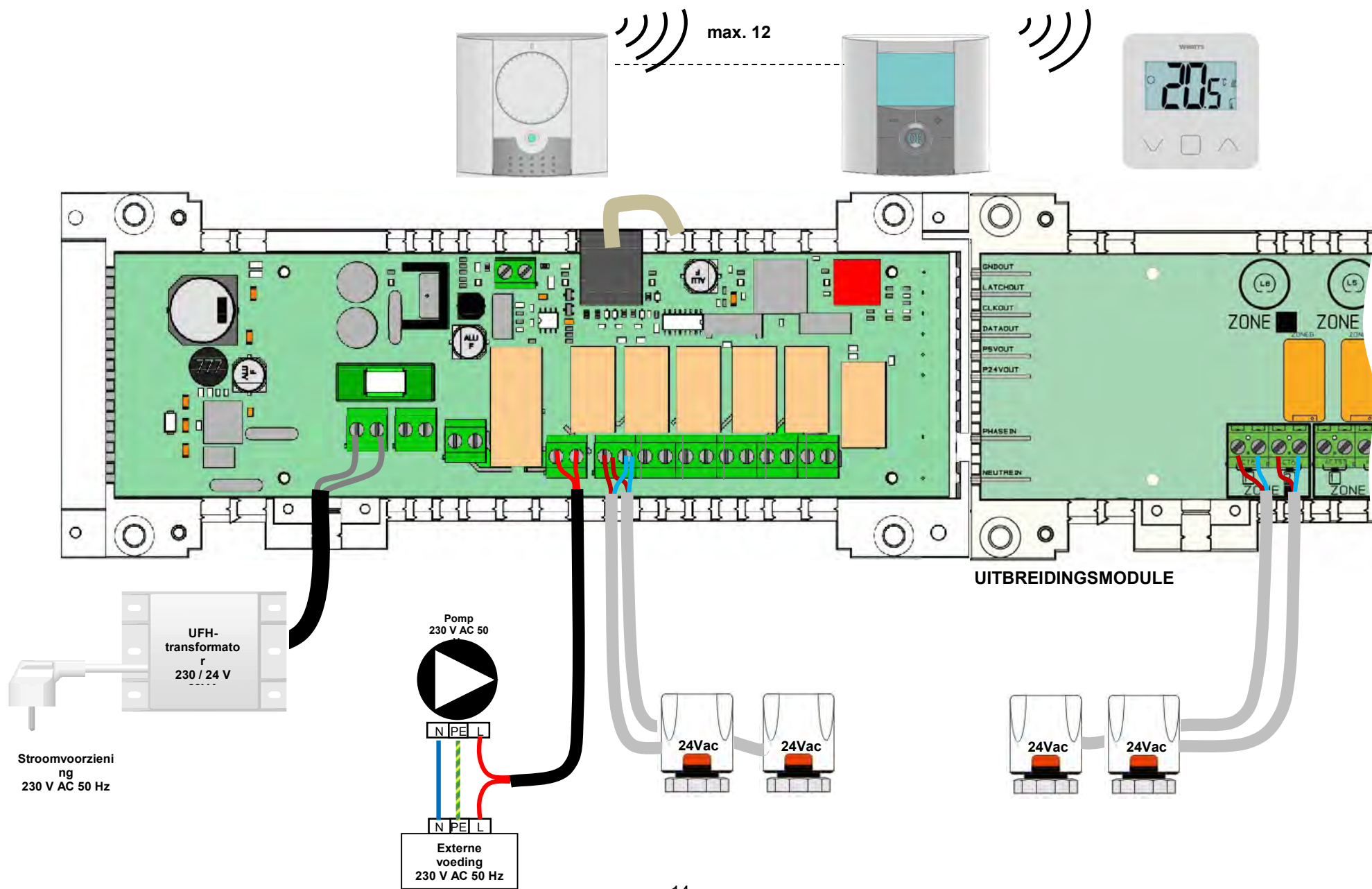

5 CORRECTE INSTALLATIE VAN HET RF-SYSTEEM

⚠ **Neem de montage-instructies in acht voor een optimale gevoeligheid en om storingen te vermijden**

Plaats de antenne:

- buiten de metalen omhulsel
- in verticale stand
- en ten minste 50cm van metalen onderdelen af

Als u meerdere antennes hebt (diverse BT-M6Z02RF / BT-HCM02-RF op dezelfde plek), moeten zij minimaal 80cm van elkaar worden geplaatst.

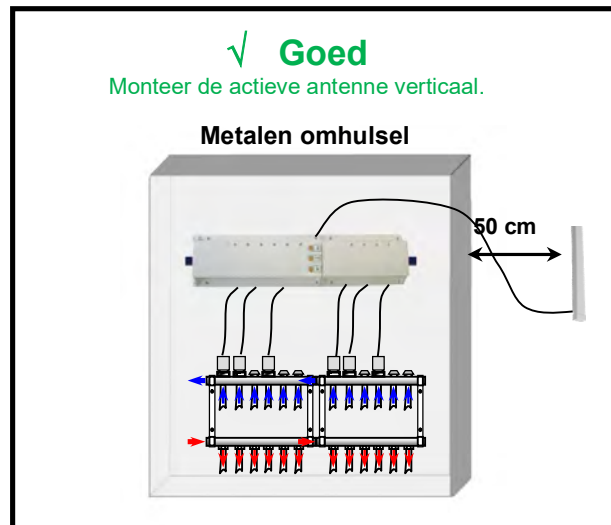

6 MOGELIJKHEDEN VAN HET SYSTEEM:

Zie de handleiding voor de configuratie van het systeem (www.wattselectronics.com), voor een toelichting van de verschillende mogelijkheden.

Wij maken onderscheid tussen 2 soorten installaties. Indien u een BT-CT02-RF in uw installatie hebt gaat u naar 6.B

6.A. Installatie zonder aanraakscherm BT-CT02-RF

In deze installatie zijn er 2 mogelijkheden:

- 3- "Standalone" installatie: Typische installaties:
 - a. Slechts één BT-M6Z02-RF
 - b. Diverse BT-M6Z02-RF's met lokaal pompbeheer
- 4- Installatie met "Centraal beheer": In dit geval moeten diverse BT-M6Z02-RF's met elkaar communiceren om de pomp correct aan te sturen met het signaal voor verwarmen/koelen.
 - a. Diverse BT-M6Z02-RF's met algemeen pompbeheer
 - b. Ten minste diverse BT-M6Z02-RF's en één BT-HCM02-RF

6.A.1 Standalone Installatie

Voorbeeld van een "Standalone Installatie"

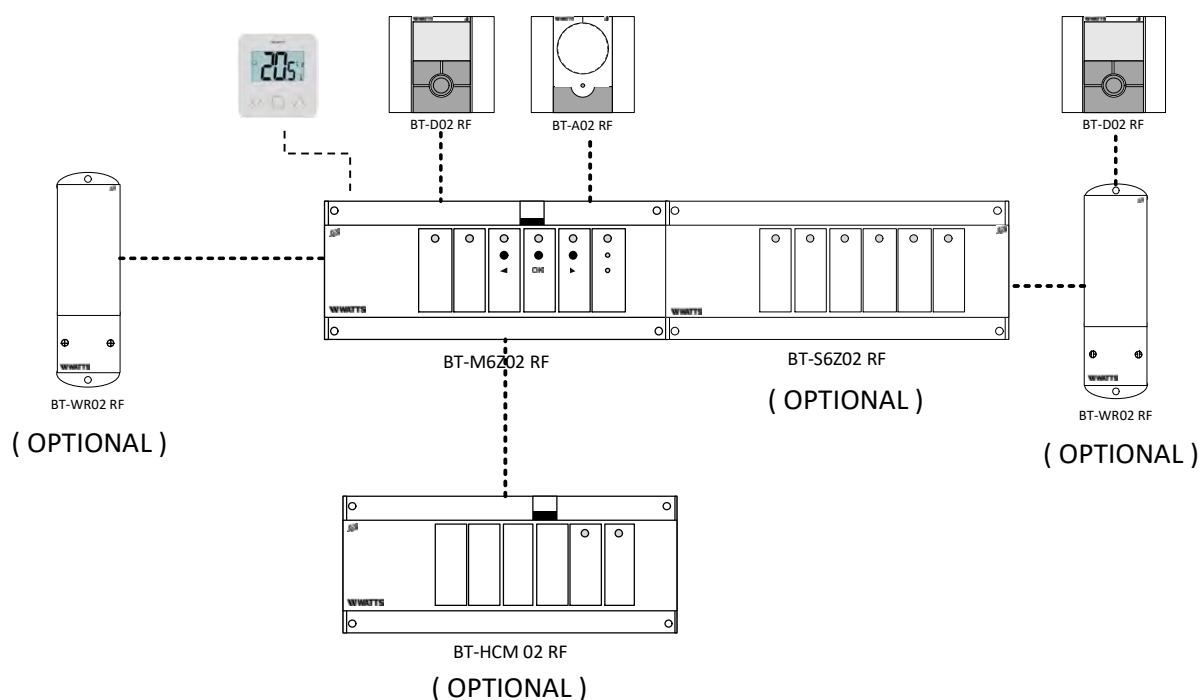

Al die elementen moeten met elkaar worden verbonden. De procedure voor de RF-verbinding wordt in de onderstaande volgorde uitgevoerd:

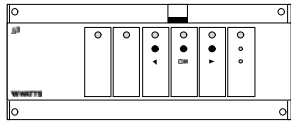
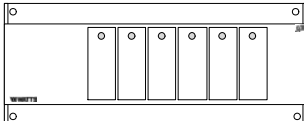
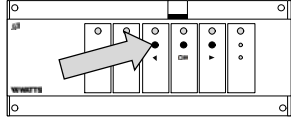
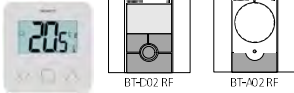
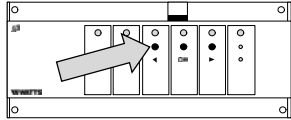
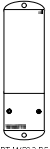
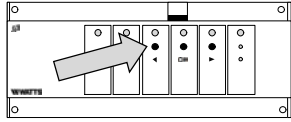
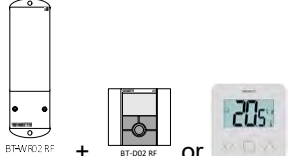
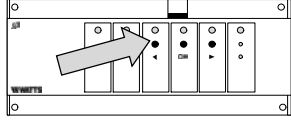
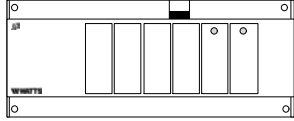
Element 1 te verbinden	Element 2 te verbinden	Opmerkingen
<p align="center">BT-M6Z02-RF</p>  <p align="center">BT-M6Z02 RF</p>	<p align="center">BT-S4Z / BT-S6Z</p>  <p align="center">BT-S6Z02 RF</p>	<p>Het is niet nodig ze te verbinden, monteer eenvoudig S4Z of S6Z met BT-M6Z02-RF (voor beide producten voeding uitgeschakeld) en u kunt de extra zones selecteren</p>
<p align="center">BT-M6Z02-RF</p>  <p align="center">BT-M6Z02 RF</p> <p>Druk 5 tellen op OK, de eerste kanaal-LED moet knipperen. Kies kanalen met < en > en selecteer/deselecteer de zone met OK. Als een zone is geselecteerd wordt hij rood. Opmerking: Druk 5 seconden op OK om deze stap te verlaten.</p>	<p align="center">BT-D03 RF / BT-D(P)02-RF / BT-A02-RF</p>  <p>Thermostaten : Zet product in de modus voor het maken van een RF-verbinding (zie desbetreffende handleiding)</p>	<p>Als de verbinding gereed is, moeten de kanalen die zijn geselecteerd op de BT-M6Z02 RF groen worden en de thermostaten moeten de verbindingmodus verlaten.</p>
<p align="center">BT-M6Z02-RF</p>  <p align="center">BT-M6Z02 RF</p> <p>Druk op < gedurende 5 tellen, alle kanaal-leds moeten groen knipperen. Product wacht op verbinding. Opmerking: Druk op < gedurende 5 tellen om deze stap te verlaten.</p>	<p align="center">BT-WR02-RF</p>  <p align="center">BT-WR02 RF</p> <p>Zet product in de modus voor het maken van een RF-verbinding.</p>	<p>In deze configuratie wordt BT-WR02-RF gebruikt voor het op afstand bedienen van de pomp of boiler: als er geen vraag is op de BT-M6Z02-RF, stuurt het apparaat de uitgang. Als de verbinding gereed is gaan BT-M6Z02-RF en BT-WR02-RF terug naar normaal bedrijf OPMERKING: in plaats van BT-WR02-RF, kunt u ook BT-FR02-RF en BT-PR02-RF gebruiken</p>
<p align="center">BT-M6Z02-RF</p>  <p align="center">BT-M6Z02 RF</p> <p>Druk op < gedurende 5 tellen, alle kanaal-leds moeten groen knipperen. Product wacht op verbinding. Opmerking: Druk op < gedurende 5 tellen om deze stap te verlaten.</p>	<p align="center">BT-WR02-RF + BT-D02-RF or BT-D03 RF</p>  <p>BT-WR02-RF moeten eerst verbonden zijn met de thermostaat. Zet BT-WR02-RF in de modus voor het maken van een RF-verbinding.</p>	<p>In deze configuratie wordt BT-WR02-RF gebruikt als extra zone. Als de verbinding gereed is gaan BT-M6Z02-RF en BT-WR02-RF terug naar normaal bedrijf OPMERKING 1: in plaats van BT-WR02-RF kunt u ook BT-FR02-RF en BT-PR02-RF gebruiken OPMERKING 2: deze configuratie is alleen mogelijk in een verwarmingsinstallatie (geen koeling)</p>
<p align="center">BT-M6Z02-RF</p>  <p align="center">BT-M6Z02 RF</p> <p>Druk op < gedurende 5 tellen, alle kanaal-leds moeten groen knipperen. Product wacht op verbinding. Opmerking: Druk op < gedurende 5 tellen om deze stap te verlaten.</p>	<p align="center">BT-HCM02-RF</p>  <p align="center">BT-HCM02 RF</p> <p>Zet product in de modus voor het maken van een RF-verbinding.</p>	<p>Als de verbinding gereed is gaan BT-M6Z02-RF en BT-HCM02-RF tegelijkertijd terug naar normaal bedrijf.</p>

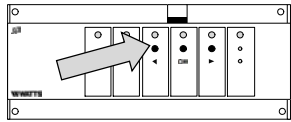
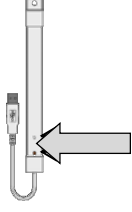
<p style="text-align: center;">BT-M6Z02-RF</p>  <p style="text-align: center;">BT-M6Z02 RF</p> <p>Druk < gedurende 5 seconden totdat alle LEDS van de zones groen knipperen. Regelaar is klaar om een signaal te ontvangen. Om uit dit menu te gaan houdt u < 5sec ingedrukt.</p>	<p>Houd het knopje op de repeater 3 sec ingedrukt (LED knippert rood-groen)</p> 	<p>Indien de verbinding is gelukt, gaat de regelaar 6 zones automatisch uit het RF menu. De LED op de repeater brandt nu groen.</p>
---	---	---

6.A.2 Installatie met centraal beheer

In deze configuratie zorgt één BT-M6Z02-RF - "Main" BT-M6Z02-RF genaamd - voor het centrale beheer van de informatie van de andere BT-M6Z02-RF – "Sub" BT-M6Z02-RF genaamd.

Haar taak is

- om het signaal voor verwarmen en koelen aan het systeem door te geven
- om de boiler / algemene pomp te hanteren voor het hele systeem.

Als er een BT-HCM02-RF in de installatie zit, MOET deze zijn verbonden met "Main" BT-M6Z02-RF.

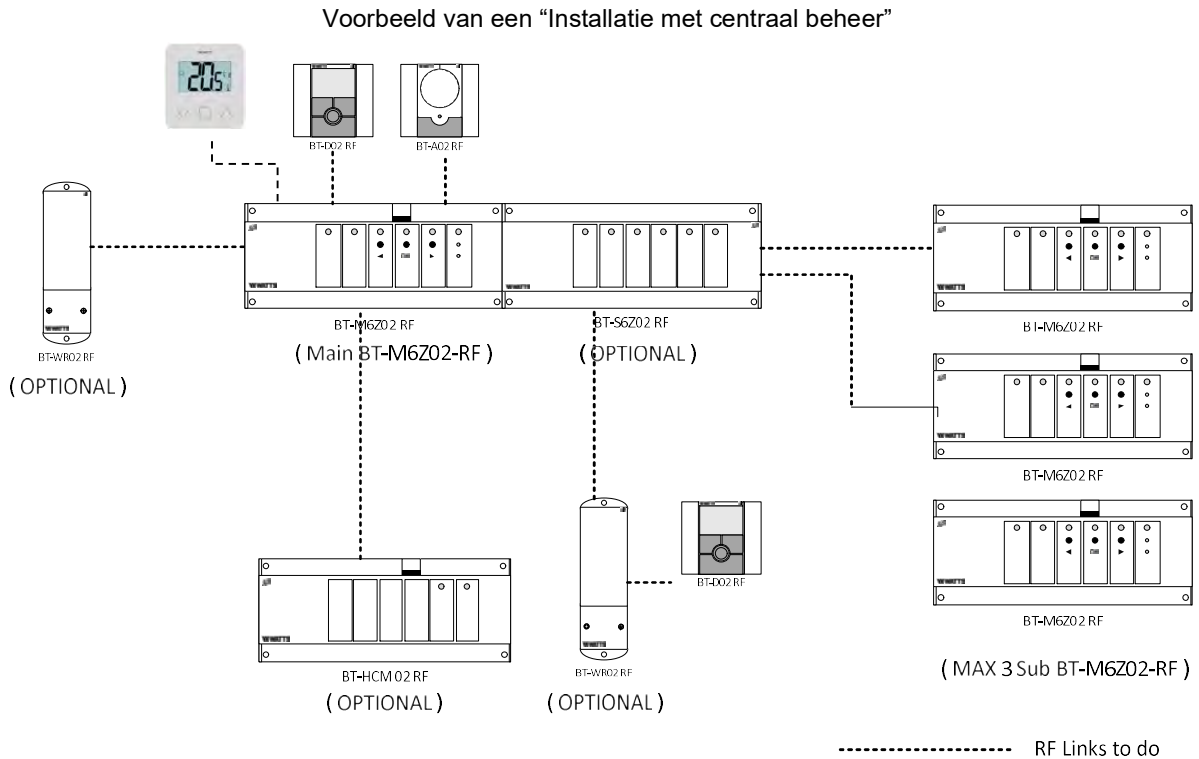

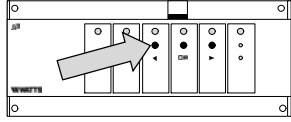
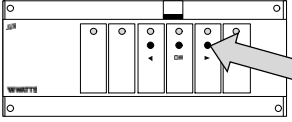
Element 1 te verbinden	Element 2 te verbinden	Opmerkingen
<p>Voer de procedure voor het maken van een RF-verbinding uit als in de Standalone versie en ga vervolgens verder met de RF-verbinding voor alle BT-M6Z02-RF's</p>		
<p style="text-align: center;">« Main » BT-M6Z02-RF</p>  <p style="text-align: center;">BT-M6Z02 RF</p> <p>Druk op < gedurende 5 tellen, alle kanaal-leds moeten groen knipperen.</p>	<p style="text-align: center;">« Sub » BT-M6Z02-RF</p>  <p style="text-align: center;">BT-M6Z02 RF</p> <p>Druk op > gedurende 5 tellen, alle kanaal-leds</p>	<p>Wanneer de verbinding gereed is gaan de twee BT-M6Z02-RF's terug naar normaal bedrijf.</p>

Product wacht op verbinding. Opmerking: Druk op < gedurende 5 tellen om deze stap te verlaten.	moeten rood knipperen. Product wacht op verbinding. Opmerking: Druk op > gedurende 5 tellen om deze stap te verlaten.	
---	---	--

6.B. Installatie met aanraakscherm BT-CT02-RF

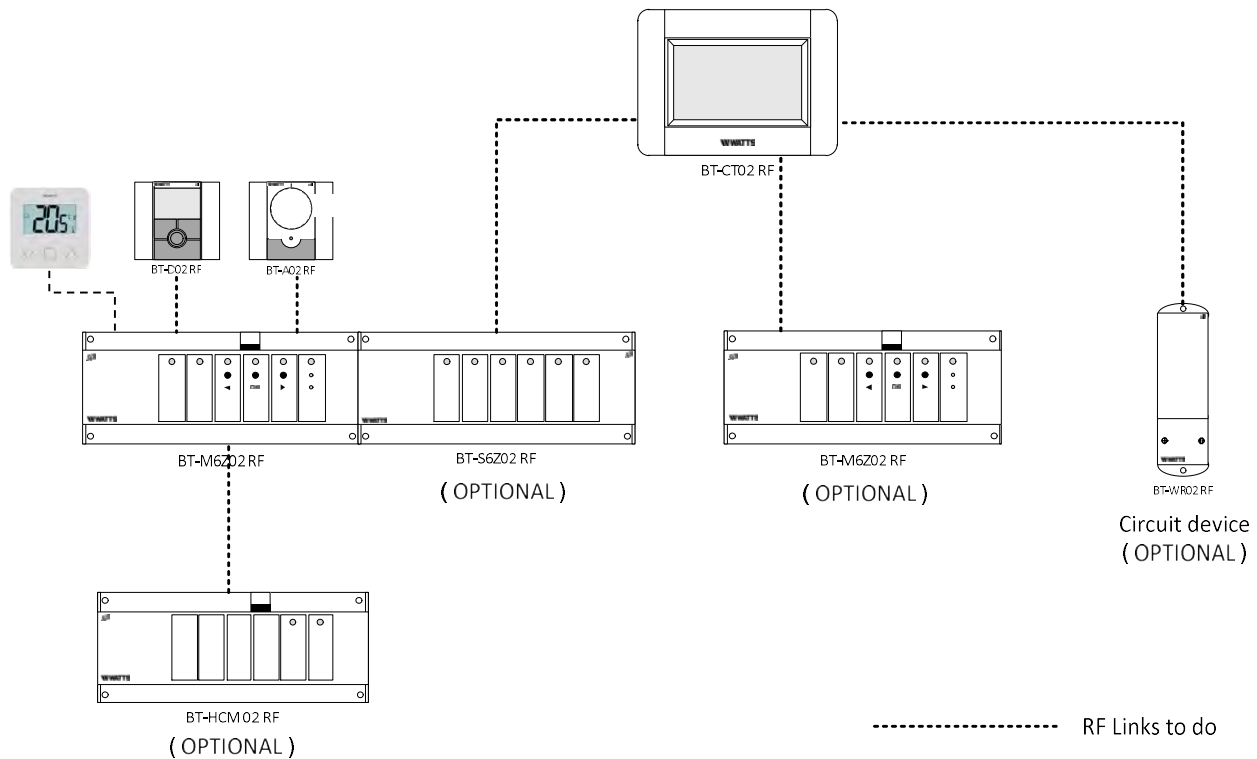

Als er een aanraakscherm BT-CT02-RF in de installatie is opgenomen, wordt alles centraal beheerd door het aanraakscherm.

Voorbeeld van een "Installatie met centraal beheer"

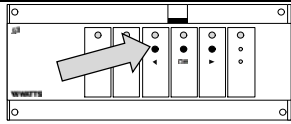
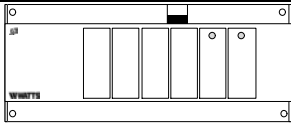
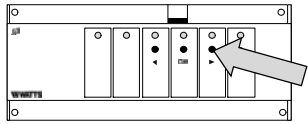
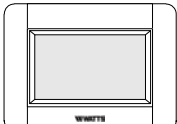
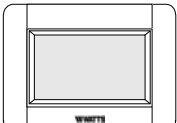

Ga in deze configuratie in de onderstaande volgorde verder met de RF-verbinding:

Element 1 te verbinden	Element 2 te verbinden	Opmerkingen
<p>BT-M6Z02-RF</p> <p>BT-M6Z02 RF</p> <p>Druk 5 tellen op OK, de eerste kanaal-LED moet knipperen. Kies kanalen met < en > en selecteer/deselecteer de zone met OK. Als een zone is geselecteerd wordt hij rood. Opmerking: Druk 5 seconden op OK om deze stap te verlaten.</p>	<p>BT-D03 RF / BT-D(P)02-RF / BT-A02-RF</p> <p>Thermostaten : Zet product in de modus voor het maken van een RF-verbinding (zie desbetreffende handleiding)</p>	<p>Als de verbinding gereed is, moeten de kanalen die zijn geselecteerd op de BT-M6Z02 RF groen worden en de thermostaten moeten de verbindingmodus verlaten.</p>
<p>BT-M6Z02-RF</p>	<p>BT-HCM02-RF</p>	<p>Als de verbinding gereed is gaan BT-M6Z02-RF en BT-HCM02-RF terug naar</p>

 <p>BT-M6Z02 RF</p> <p>Druk op < gedurende 5 tellen, alle kanaal-leds moeten groen knipperen. Product wacht op verbinding. Opmerking: Druk op < gedurende 5 tellen om deze stap te verlaten.</p>	 <p>BT-HCM02 RF</p> <p>Zet product in de modus voor het maken van een RF-verbinding.</p>	<p>normaal bedrijf</p> <p>OPMERKING: slechts één BT-HCM02-RF in de installatie</p>
<p>BT-M6Z02-RF</p>  <p>BT-M6Z02 RF</p> <p>Druk op > gedurende 5 tellen, alle kanaal-leds moeten rood knipperen. Product wacht op verbinding. Opmerking: Druk op > gedurende 5 tellen om deze stap te verlaten.</p>	<p>BT-CT02-RF</p>  <p>BT-CT02 RF</p> <p>Verbinden als een normale zone</p>	
<p>BT-CT02-RF</p>  <p>BT-CT02 RF</p> <p>« Circuit » apparaat verbinden</p>	<p>BT-WR02-RF</p>  <p>BT-WR02 RF</p> <p>Zet product in de modus voor het maken van een RF-verbinding.</p>	<p>In deze configuratie wordt BT-WR02-RF gebruikt als apparaat voor het hydraulisch circuit. Zie de handleiding van BT-CT02-RF voor een nadere toelichting.</p>

Let goed op! Verbind BT-M6Z02-RF met BT-CT02-RF als ALLE thermostaten naar BT-M6Z02-RF zijn verbonden.

7 SPECIALE FUNCTIES

Vochtigheidsbeheer

Deze functie is beschikbaar op thermostaten met een vochtigheidssensor (BT-D02RF RH en BT-DP02RF RH).

In de handleiding van de thermostaat ziet u hoe u de parameters correct kunt instellen.

- Als er een afwijking is in de vochtigheid (dauwpunt of vochtigheidsdrempel), wordt koeling in de zone gestopt (stopt doorstroom in de zone).
- Als er een BT-HCM02-RF in de installatie is opgenomen en de ontvochtiger actief is, dan gaat de ontvochtiger werken als de er een afwijking is in de vochtigheid

Vertraging pomp (kan niet worden geconfigureerd)

Ter voorkoming van schade aan de pomp en geluiden in het hydraulische circuit (van het water dat door de leidingen stroomt), start de pomp pas 1 minuut na de warmtevraag van de zone-thermostaten. Deze vertraging moet de afsluiter in staat stellen volledig te openen voordat de pomp wordt geactiveerd.

Kleppentest (kan niet worden geconfigureerd)

Om te voorkomen dat de kleppen vast gaan zitten wordt iedere klep automatisch 2 minuten per week geactiveerd.

Fabrieksinstellingen herstellen:

Met deze functie wist u alle instellingen en RF-verbindingen en zet u de configuratie terug op de fabriekswaarden.

Druk bij normaal bedrijf ('Run') vijf tellen lang tegelijk op de knoppen (◀) en (▶).
Dan is het product gereset.

1 GUIDE UTILISATEUR

La boîte de connexion BT-M6Z02-RF est spécialement conçue pour contrôler votre système de chauffage et de refroidissement au sol.

Il peut gérer les vannes normalement fermées ou normalement ouvertes.

La boîte de connexion BT-M6Z02-RF a été conçue avec 6 sorties et ce nombre peut être étendu jusqu'à 10 ou 12 avec un boîtier d'extension.

BT-M6Z02-RF fonctionne avec des thermostats liés en RF (Radio Fréquence); Il peut comporter jusqu'à 12 thermostats qui lui sont liés et gérer en parallèle 12 régulations indépendantes.

Il fonctionne avec tous les thermostats de la gamme BT02 RF ou BT03 RF.

Les caractéristiques spéciales de BT-M6Z02-RF sont:

- sortie de la pompe ou de la chaudière (filaire ou sans fil avec BT-WR02-RF)
- Gestion de l'humidité (via BT-D02-RF RH et BT-DP02-RF RH)
- Gestion de l'entrée du signal de chauffage et du refroidissement (via BT-HCM02-RF)
- Gestion de déshumidificateur (via BT-HCM02-RF)
- Connexion à l'unité centrale BT-CT02-RF

2 CARACTERISTIQUES TECHNIQUES

Modèle	BT-M6Z02-RF 230V	BT-M6Z02-RF 24V
Température de fonctionnement	0°C à 50°C	
Caractéristiques de régulation	Régulation proportionnelle intégrale ou régulation hystérésis. La régulation est définie par le thermostat lié à la zone (se reporter à la notice du thermostat)	
Alimentation	230VAC +- 10% 50Hz	24Vac +- 10% 50Hz
Sorties: Pompe ou accessoires vannes (normalement fermée)	Relai => 5A / 250VAC (contact libre) Relai => 5A / 230 VAC (L, N) Pour une installation simple, nous recommandons un maximum de 4 vannes par zones.	Relai => 5A / 250Vac (contact libre) Triac => 3A / 24Vac Le nombre total de vannes est limité par le transformateur (60VA), le fusible (2,5A) et la puissance des vannes
Fréquence radio	868,3 MHz, <10mW. Rayon d'environ 180 mètres en milieu ouvert. Rayon d'environ 50 mètres en milieu résidentiel.	
Directives CE Votre produit a été conçu en conformité avec les directives européennes :	Directive 2001/95/CE sur les conditions générales de sécurité des produits Directive basse tension 2014/35/UE Équipement radio Directive 2014/53/UE Directive RoHS 2011/65/UE Directive EMC 2014/30/UE	
Protection	IP 30	
Compatibility	Avec BT S4Z02 RF: 10 Zones => 1 Master 6 + 1 Slave 4 zones Avec BT S6Z02 RF: 12 Zones => 1 Master 6 + 1 Slave 6 zones BT-HCM02 RF BT-WR02-RF, BT-WR02 FC RF BT-PR02-RF BT-FR02-RF BT-CT02-RF Répéteur RF BT-A02 RF BT-D02 RF, BT-D02 RH RF BT-DP02 RF, BT-DP02 RH RF BT-D03 RF	

3 Interface utilisateur



3.A. Signification de la couleur des LED

Sur le BT-M6Z02-RF il y a une Led bicolore par zone (1) à (6) et 2 leds pour des états complémentaires.
En mode de fonctionnement normal:

- (1) à (6):
 - o Rouge fixe: Indicateur de demande de chauffage ou de refroidissement (circulation de l'eau sur cette zone)
 - o Flash vert: Signal RF reçu du thermostat affecté à cette zone
 - o Clignotement rouge: Alarme RF, la communication entre le thermostat et le BT-M6Z02-RF a été perdue (dans ce cas, vérifiez les piles sur ce thermostat)
 - o Rouge clignotant sur toutes les zones: vérifiez la connexion de l'antenne RF
- (7): indicateur du circulateur
 - o Vert lorsque la sortie du circulateur est active
- (8): indicateur de chauffage et de refroidissement
 - o Vert lors du refroidissement
 - o Rouge lors du chauffage
 - o Clignotement rouge ou vert: Alarme RF entre le BT-M6Z02 RF et tout appareil autre qu'un thermostat

En mode de liaison RF, les indicateurs Leds (1) à (6) ont une signification différente, voir section 6

3.B. Boutons

Sur le BT-M6Z02-RF, il y a 3 boutons "<", "OK" et ">".

Ils sont utilisés pour:

- liés des produits aux BT-M6Z02-RF: reportez-vous à la section 7
- faire une réinitialisation d'usine (réinitialiser toutes les configurations et tous les liens RF): voir la section 7

3.C. Configuration du DIP switch

Lorsque vous dévissez la face avant de BT-M6Z02-RF, vous avez accès à 4 commutateurs utilisés pour la configuration avancée:

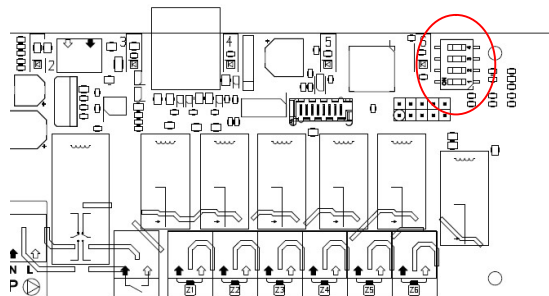

Par défaut, la position est désactivée pour les 4 commutateurs

Commutateur 1: Configuration du circulateur local / Global (sortie du circulateur ET dispositif de contrôle du circulateur à distance)

ON (global): BT-M6Z02-RF active le circulateur s'il existe une demande de chauffe ou de rafraichissement dans le système

OFF (local): BT-M6Z02-RF active le circulateur uniquement s'il existe une demande de chauffe ou de rafraichissement sur le BT-M6Z02-RF

Commutateur 2: Configuration NO / NC

ON (NO): Les sorties (vannes) sont normalement ouvertes

OFF (NC): les sorties (vannes) sont normalement fermées

Switch 3: Configuration de l'exercice du circulateur

ON: Une fois par semaine, la sortie du circulateur est activée

OFF: aucune action sur la sortie du circulateur

Switch 4: Pas d'action

4 DIAGRAMME DE CABLAGE

4.1 DIAGRAMME DE CABLAGE 230V

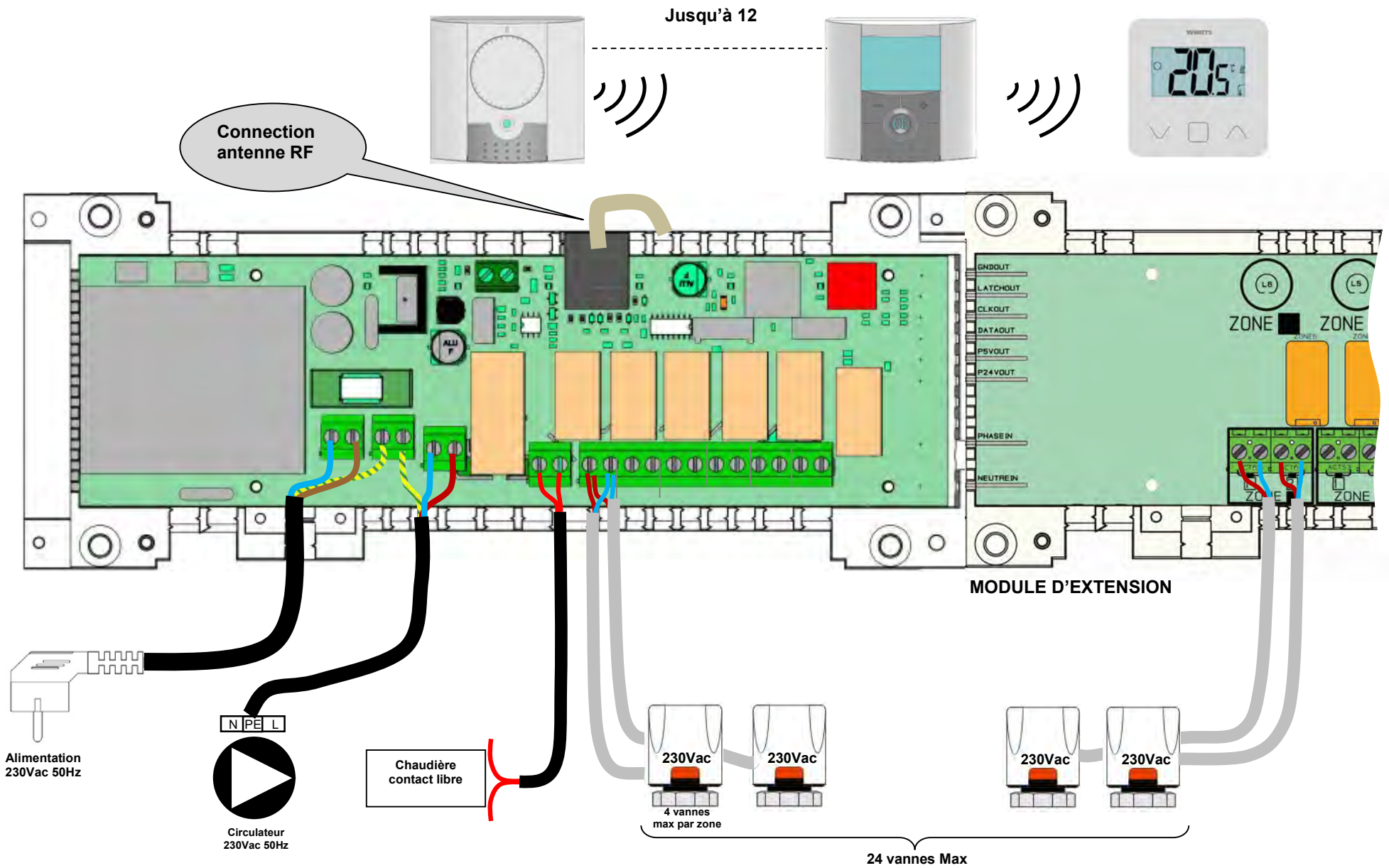

4.2 DIAGRAMME DE CABLAGE 24V

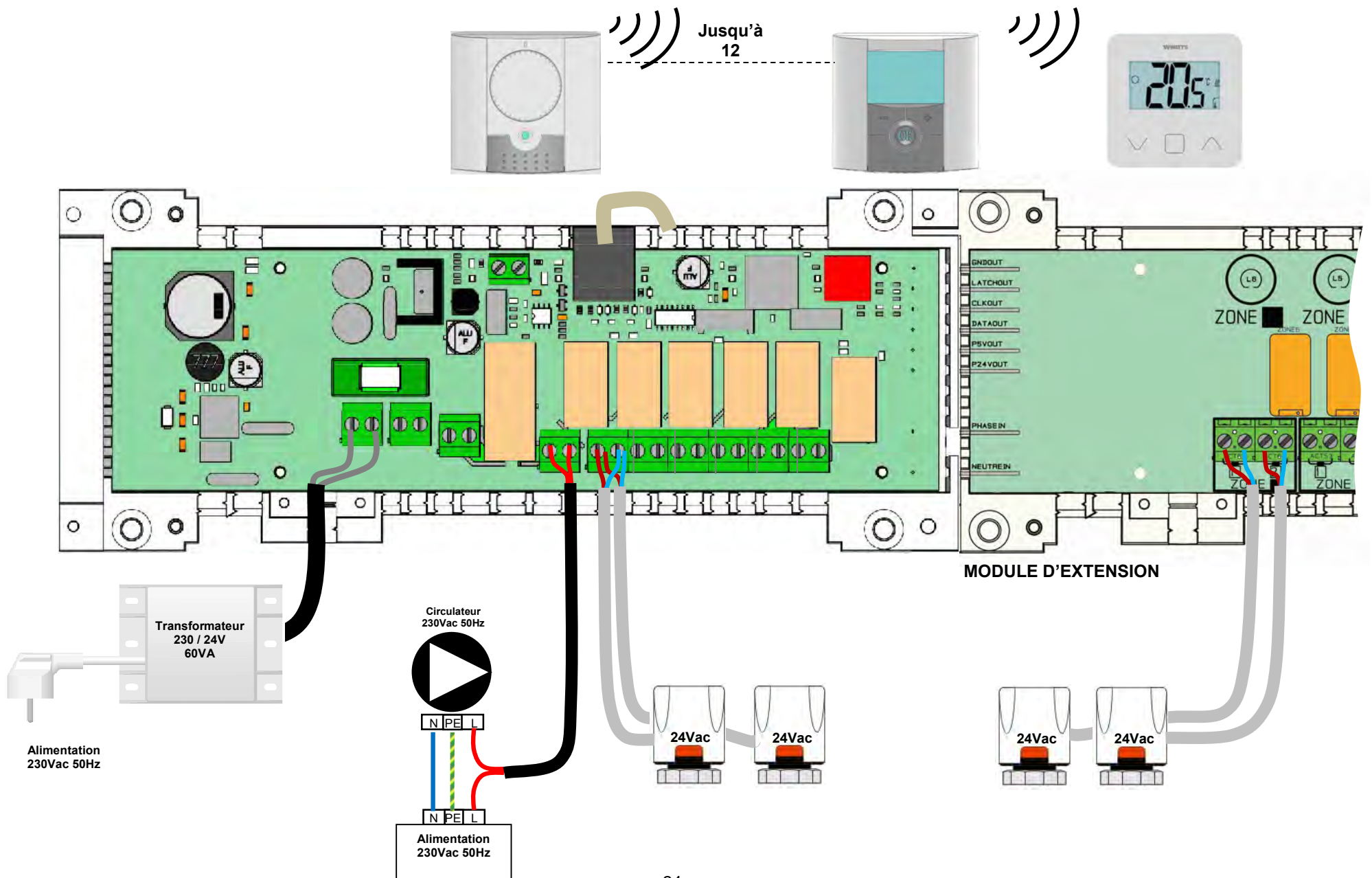

5 COMMENT INSTALLER CORRECTEMENT VOTRE SYSTEME



Veuillez respecter le montage pour optimiser la sensibilité et éviter tout dysfonctionnement

L'antenne doit être placée:

- en dehors de la boîte métallique
- en position verticale
- à au moins 50cm de pièces métalliques

Si vous avez plusieurs antennes (plusieurs BT-M6Z02RF / BT-HCM02-RF au même endroit), elles doivent être placées au minimum 80 cm l'une de l'autre.

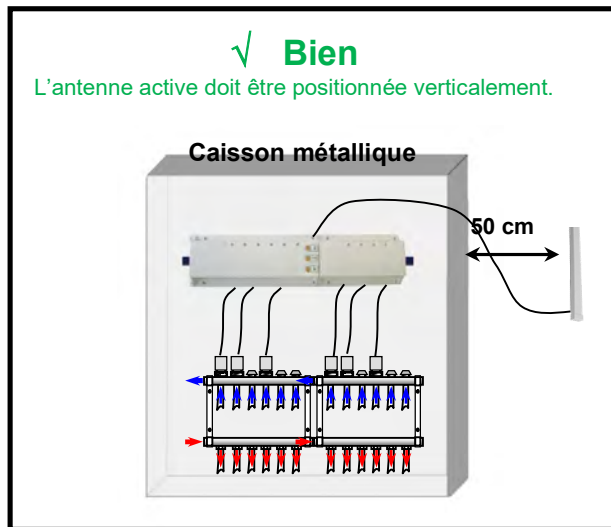

6 CONFIGURATION DU SYSTEME:

Reportez-vous au manuel de configuration du système (www.wattselectronics.com) pour plus d'informations sur les différentes possibilités.

Nous distinguons 2 types d'installation, si vous avez une unité centrale BT-CT02-RF dans votre installation, passez à 6.B

6.A. Installation avec unité centrale BT-CT02-RF

Dans cette installation, nous avons 2 possibilités:

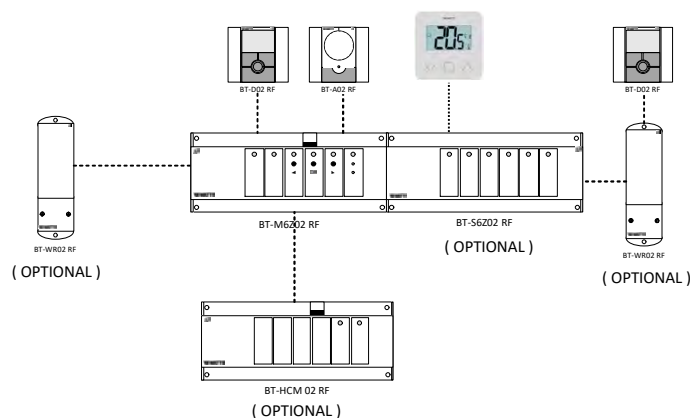

- 1- Installation "seule": Installations typiques:
 - a. 1 seul BT-M6Z02-RF
 - b. Plusieurs BT-M6Z02-RF avec gestion local d'un circulateur
- 2- Installation centralisée: Dans ce cas, il existe plusieurs BT-M6Z02-RF qui doivent communiquer ensemble pour générer correctement le signal déclenchant le circulateur et la chaudière
 - a. Plusieurs BT-M6Z02-RF avec gestion globale du circulateur
 - b. Plusieurs BT-M6Z02-RF et un BT-HCM02-RF

6.A.1 Installation seule - Exemple d'installation seule

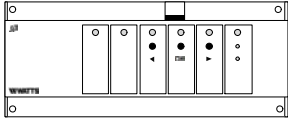
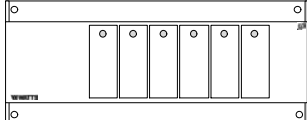
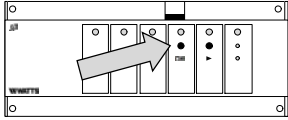
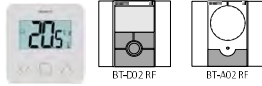
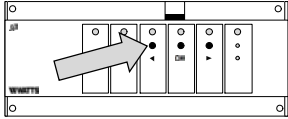

----- RF Links to do

Tous ces éléments doivent être liés ensemble, la procédure de liaison RF peut être effectuée dans cet ordre:

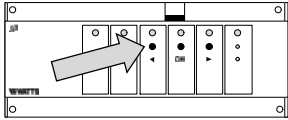
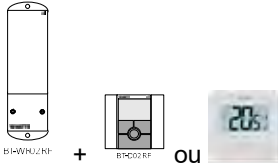
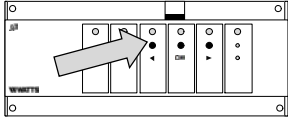
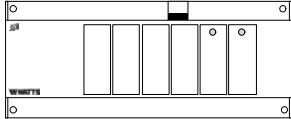
Element 1 du lien	Element 2 du lien	Commentaires
<p align="center">BT-M6Z02-RF</p>  <p align="center">BT-M6Z02 RF</p>	<p align="center">BT-S4Z / BT-S6Z</p>  <p align="center">BT-S6Z02 RF</p>	<p>Pas besoin de les relier en RF, assemblez simplement le BT-S4Z ou BT-S6Z avec le BT-M6Z02-RF (les deux produits sont hors tension) et vous pouvez sélectionner les zones supplémentaires</p>
<p align="center">BT-M6Z02-RF</p>  <p align="center">BT-M6Z02 RF</p> <p>Appuyez sur OK pendant 5 secondes, le premier canal doit clignoter. Choisissez les canaux avec < et > et sélectionnez / désélectionnez la zone avec OK. Lorsqu'une zone est sélectionnée, elle devient Rouge. Remarque: Pour quitter, appuyez sur OK pendant 5 secondes.</p>	<p align="center">BT-D03 RF /BT-D(P)02-RF / BT-A02-RF</p>  <p>Thermostats: Mettez le produit en mode de liaison RF (reportez-vous au manuel d'instructions correspondant)</p>	<p>Si le lien est terminé, les leds des canaux sélectionnés sur le BT-M6Z02 RF doivent être verts et les thermostats doivent quitter le mode de liaison RF.</p>
<p align="center">BT-M6Z02-RF</p>  <p align="center">BT-M6Z02 RF</p> <p>Appuyez sur < pendant 5 secondes, tous les leds de canal doivent clignoter en vert. Le produit attend le lien. Remarque: Pour sortir, appuyez sur < pendant 5 secondes.</p>	<p align="center">BT-WR02-RF</p>  <p align="center">BT-WR02 RF</p> <p>Mettez le produit en mode lien RF (reportez-vous au manuel d'instructions correspondant)</p>	<p>Dans cette configuration, BT-WR02-RF est utilisé comme sur un circulateur à distance ou une chaudière: s'il existe une demande sur le BT-M6Z02-RF, l'appareil commandera la sortie. Lorsque le lien est fait, BT-M6Z02-RF et BT-WR02-RF retournent en mode normal REMARQUE: Au lieu de BT-WR02-RF, vous pouvez également utiliser BT-FR02-RF et BT-PR02-RF</p>
<p align="center">BT-M6Z02-RF</p>  <p align="center">BT-M6Z02 RF</p> <p>Appuyez sur < pendant 5 secondes, tous les leds de canal doivent clignoter en vert. Le produit attend le lien. Remarque: Pour sortir, appuyez sur < pendant 5 secondes.</p>	<p align="center">BT-WR02-RF + BT-D02-RF / BT-D03 RF</p>  <p>BT-WR02-RF doit d'abord être lié au thermostat. Mettez BT-WR02-RF en mode RF Link.</p>	<p>Dans cette configuration, BT-WR02-RF est utilisé comme zone supplémentaire. Lorsque le lien est fait BT-M6Z02-RF et BT-WR02-RF retournent en mode normal REMARQUE 1: au lieu de BT-WR02-RF, vous pouvez également utiliser BT-FR02-RF et BT-PR02-RF REMARQUE 2: cette confédération n'est possible que dans l'installation de chauffage (pas de refroidissement)</p>
<p align="center">BT-M6Z02-RF</p>  <p align="center">BT-M6Z02 RF</p> <p>Appuyez sur < pendant 5 secondes, tous les leds de canal doivent clignoter en vert. Le produit attend le lien. Remarque: Pour sortir, appuyez sur < pendant 5 secondes.</p>	<p align="center">BT-HCM02-RF</p>  <p align="center">BT-HCM02 RF</p> <p>Mettez le produit en mode RF Link.</p>	<p>Lorsque le lien est fait, BT-M6Z02-RF et BT-HCM02-RF retournent en mode normal en même temps.</p>

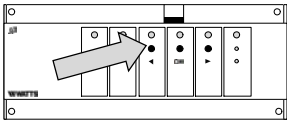
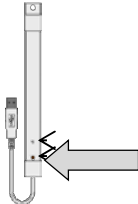
<p style="text-align: center;">BT-M6Z02-RF</p>  <p style="text-align: center;">BT-M6Z02 RF</p> <p>Appuyez sur < pendant 5 secondes, tous les leds de canal doivent clignoter en vert. Le produit attend le lien. Remarque: Pour sortir, appuyez sur < pendant 5 secondes.</p>	<p>Mettre le répéteur RF en mode d'appairage radio (appuyer 3s sur le bouton)</p> 	<p>Quand l'appairage a réussi, le BT-M6Z02 RF retourne au mode normal et la led sur répéteur devient verte fixe..</p>
---	---	---

6.A.2 Installation centralisée

Dans cette configuration, un BT-M6Z02-RF - appelé "Main" BT-M6Z02-RF - centralisera l'information de l'autre BT-M6Z02-RF - appelée "Sub" BT-M6Z02-RF.

Son rôle est

- de propager le signal de chauffage et de refroidissement vers le système
- de gérer la chaudière / circulateur global pour l'ensemble du système.

S'il y a un BT-HCM02-RF dans l'installation, il DOIT être lié au "Main" BT-M6Z02-RF.

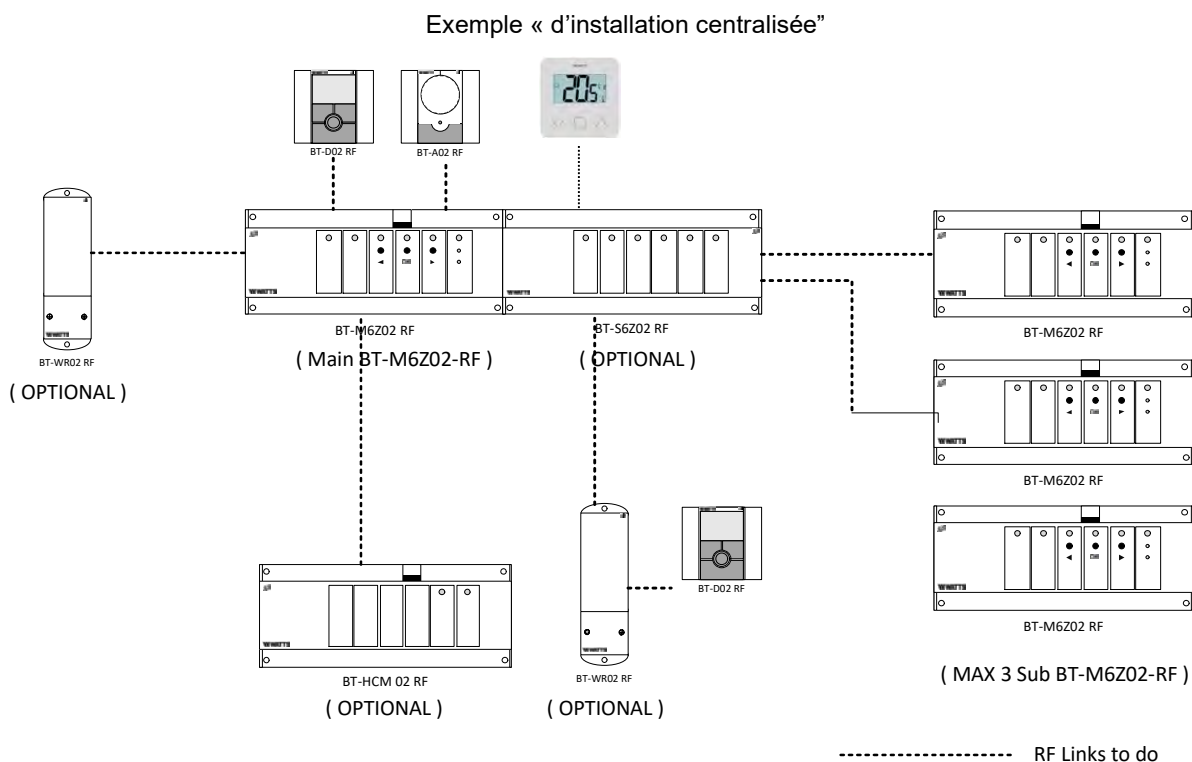

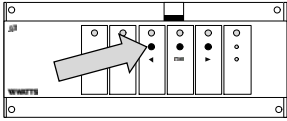
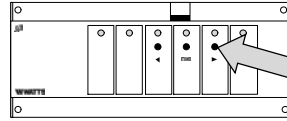
Element 1 du lien	Element 2 du lien	Commentaires
<p>Exécuter la procédure de liaison RF comme dans la version autonome, puis procédez à la liaison RF de tous les BT-M6Z02-RF</p>		
<p style="text-align: center;">« Main » BT-M6Z02-RF</p>  <p style="text-align: center;">BT-M6Z02 RF</p> <p>Appuyez sur < pendant 5 secondes, tous les leds de canal doivent clignoter en vert. Le produit attend le lien. Remarque: Pour sortir, appuyez sur < pendant 5 secondes.</p>	<p style="text-align: center;">« Sub » BT-M6Z02-RF</p>  <p style="text-align: center;">BT-M6Z02 RF</p> <p>Appuyez sur > pendant 5 secondes, tous les leds du canal doivent clignoter en rouge. Le produit attend le lien.</p>	<p>Lorsque le lien est terminé, les deux BT-M6Z02-RF reviennent au mode normal.</p>

Remarque: Pour sortir, appuyez su r> pendant 5 secondes.

6.B. Installation avec unite centrale BT-CT02-RF

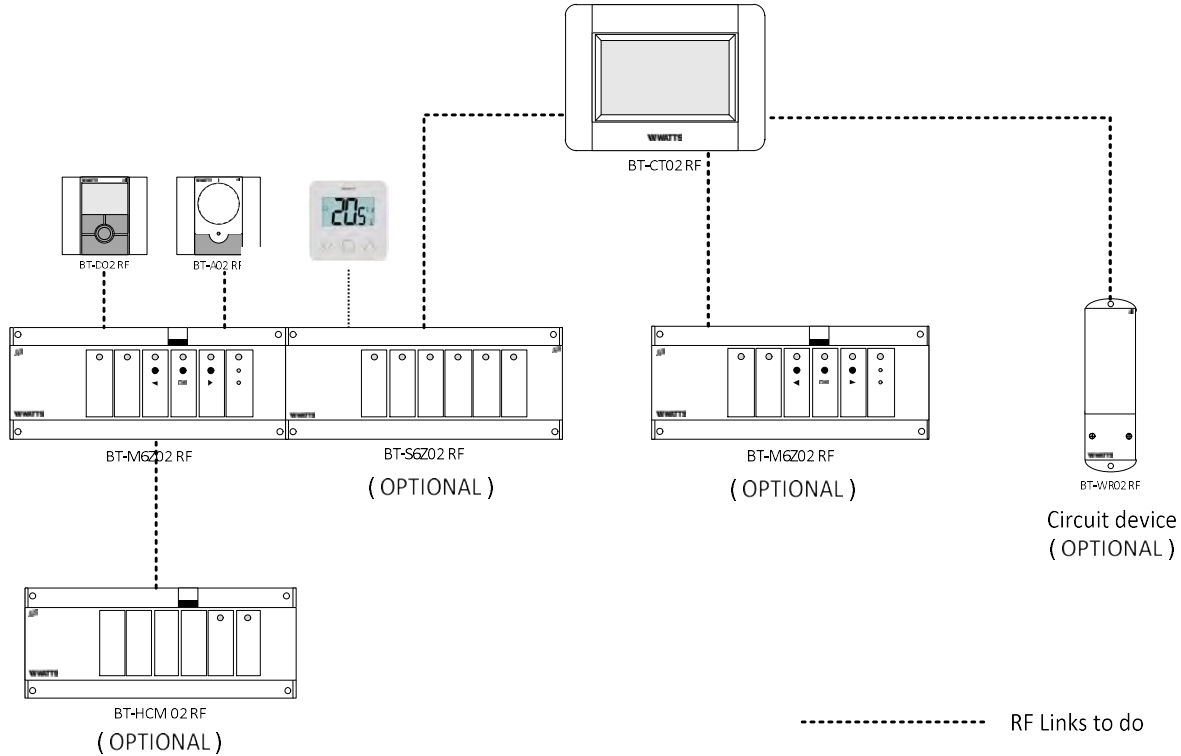

S'il y a une unite centrale BT-CT02-RF dans l'installation, tout est centralisé par l'écran tactile.

Exemple d' "Installation centralisée"

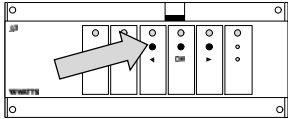
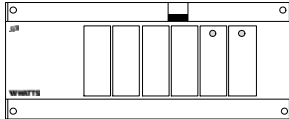
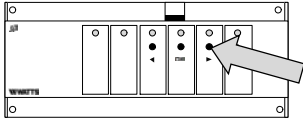
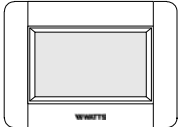
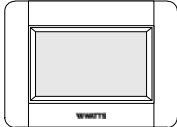

Pour cette configuration, procéder aux appairages RF dans cet ordre.

Element 1 du lien	Element 2 du lien	Commentaires
<p>BT-M6Z02-RF</p> <p>Appuyez sur OK pendant 5 secondes, le premier canal doit clignoter. Choisissez les canaux avec < ou > et sélectionnez / désélectionnez la zone avec OK. Lorsqu'une zone est sélectionnée, elle devient Rouge. Remarque: Pour sortir, appuyez sur OK pendant 5 secondes.</p>	<p>BT-D03 RF / BT-D(P)02-RF / BT-A02-RF</p> <p>Thermostats: Mettez le produit en mode de liaison RF (reportez-vous au manuel d'instructions correspondant)</p>	<p>Si le lien est terminé, les leds des chaînes sélectionnées sur le BT-M6Z02 RF doivent être Vert et les thermostats doivent quitter le mode de liaison.</p>
<p>BT-M6Z02-RF</p>	<p>BT-HCM02-RF</p>	<p>Lorsque le lien est fait BT-M6Z02-RF et BT-HCM02-RF retournent en mode normal.</p> <p>REMARQUE: un seul BT-HCM02-</p>

 <p>BT-M6Z02 RF</p> <p>Appuyez sur < pendant 5 secondes, tous les leds de canal doivent clignoter en vert. Le produit attend le lien. Remarque: Pour quitter, appuyez sur < pendant 5 secondes.</p>	 <p>BT-HCM02 RF</p> <p>Mettre le produit en mode de lien RF.</p>	<p>RF par installation</p>
<p>BT-M6Z02-RF</p>  <p>BT-M6Z02 RF</p> <p>Appuyez sur > pendant 5 secondes, tous les leds du canal doivent clignoter en rouge. Le produit attend le lien. Remarque: Pour sortir, appuyez sur > pendant 5 secondes.</p>	<p>BT-CT02-RF</p>  <p>BT-CT02 RF</p> <p>Procéder à l'appairage RF dans une zone (reportez-vous au manuel d'instructions correspondant)</p>	
<p>BT-CT02-RF</p>  <p>BT-CT02 RF</p> <p>Dispositif de liaison «Circuit»</p>	<p>BT-WR02-RF</p>  <p>BT-WR02 RF</p> <p>Mettre le produit en mode RF Link.</p>	<p>Dans cette configuration, BT-WR02-RF est utilisé comme dispositif de gestion de circuit hydraulique: Reportez-vous au mode d'emploi de BT-CT02-RF pour plus d'explications.</p>

Faites attention! Lier le BT-M6Z02-RF au BT-CT02-RF, une fois que tous les thermostats sont liés au BT-M6Z02-RF.

7 FONCTIONS SPECIALES

Gestion de l'humidité

Cette fonctionnalité est disponible sur les thermostats qui ont un capteur d'humidité (BT-D02RF RH et BT-DP02RF RH).

Veuillez vous référer au manuel d'instructions du thermostat pour régler correctement les paramètres.

- S'il y a une humidité détectée (point de rosée ou seuil d'humidité), le refroidissement de la zone est arrêté (Fermeture de la vanne dans la zone).
- Si dans l'installation il y a un BT-HCM02-RF et si un déshumidificateur est installé alors s'il y a de l'humidité détecté, le déshumidificateur est actif.

Délai de la pompe (non configurable)

Pour éviter les dommages de la pompe et le bruit dans le circuit hydraulique (débit d'eau dans le tuyau), le démarrage de la pompe sera retardé pendant 1 minute après une demande de chauffage des thermostats de la zone. Ce délai doit permettre à la vanne d'être ouverte complètement avant l'activation de la pompe.

Exercice de vanne (non configurable)

Pour empêcher les vannes de se gripper, chaque vanne est activée automatiquement 2 minutes par semaine.

Fonction de configuration d'usine:

Utilisez cette fonction pour effacer toutes les configurations, les liens RF et restaurer les paramètres d'usine. En mode de marche, appuyez simultanément pendant 5 secondes sur les 2 touches (◀) et (▶) ce qui provoque la réinitialisation du produit.

1 BEDIENUNGSANLEITUNG

Der Funk-Regelverteiler BT-M6Z02-RF ist für die Regelung von Flächenheizungen/ -kühlungen konzipiert.

Er dient zur Steuerung von Stellantrieben stromlos geschlossenen (NC) oder stromlos offen (NO).

Der Funk-Regelverteiler verfügt über 6 Ausgänge zum Anschluss der Stellantriebe von bis zu 6 Zonen. Durch die optionalen Funk-Regelverteiler Erweiterungen BT-S4Z02-RF oder BT-S6Z02-RF kann die Anzahl der Ausgänge/Zonen auf 10 bzw. 12 erweitert werden.

Per Funk können so bis zu 12 Funk-Thermostate aufgeschaltet und die Raumtemperatur von 12 Zonen (Räume) parallel geregelt werden.

Das Gerät arbeitet mit allen Funk-Thermostaten der Serie BT-..02-RF / BT-..03-RF

Besondere Merkmale zu BT-M6Z02-RF:

- Schaltausgang für Pumpe oder Wärmerzeuger (verdrahtet oder per Funk über BT-WR02-RF)
- Luftfeuchte Management (via Funk-Thermostat Hygrostat BT-D02-RF RH und BT-DP02-RF RH)
- Signal Eingang Heizen und Kühlen (über Heizen-Kühlen Modul BT-HCM02-RF)
- Ausgang für Luftentfeuchter (über Heizen-Kühlen Modul BT-HCM02-RF)
- Anschluss / Einbindung der Zentraleinheit BT-CT02- RF oder BT-CT02- RF WiFi

2 TECHNISCHE DATEN

	BT-M6Z02-RF 230V	BT-M6Z02-RF 24V
Betriebstemperatur	0°C bis 50°C	
Regelcharakteristik	Proportional Integral Regelung oder Hysterese Regelung. Die Regelart wird durch den entsprechenden Funk-Thermostat definiert (siehe Bedienungsanleitung Funk-Thermostat)	
Betriebsspannung	230 VAC ±10% 50Hz	24 VAC ±10% 50Hz
Ausgänge: Pumpe oder Zubehör Stellantriebe	Relais 5 A / 250 VAC (Potenzialfrei) Relais 5 A / 230 VAC (LIVE [L, N]) Maximal 4 Stellantriebe je Zone.	Relais 5 A / 250 VAC (Potenzialfrei) Triac => 3 A / 24 VAC Die max. Anzahl der Stellantriebe ist limitiert und richtet sich nach dem eingesetzten Transformator (60 VA), der Sicherung (2,5 A) und der Leistung der Stellantriebe.
Funk Frequenz	868 MHz < 10mW Reichweite ca. 100 m offene Distanz (im Freien). Reichweite ca. 30 m innerhalb von Gebäuden	
CE-Richtlinien Das Produkt wurde in Übereinstimmung mit den EU-Richtlinien konzipiert.	Richtlinie 2001/95/EG über die allgemeine Produktsicherheit Niederspannungsrichtlinie 2014/35/EU Richtlinie 2014/53/EU für Funkanlagen RoHS-Richtlinie 2011/65/EU EMV-Richtlinie 2014/30/EU	
Produkt entsprach: Klassifizierung: Beitrag:	UE 811/2013 und 2010/30/U IV (2%)	
Schutzart	IP 30	
Kompatibilität / Kombination mit	10 Zonen → 1 Stück BT-M6Z02-RF plus 1 Stück BT-S4Z02-RF 12 Zonen → 1 Stück BT-M6Z02-RF plus 1 Stück BT-S6Z02-RF BT-WR02-RF LC/FC, Funk-Empfänger Aufputz (LIVE/FREE Kontakt) BT-PR02-RF, Funk-Empfänger Steckdose BT-FR02-RF, Funk-Empfänger Unterputz BT-CT02-RF, Touch Screen Zentraleinheit (ohne / mit WiFi) BT-FVR02-RF, Repeater BT-HCM02-RF, Heizen / Kühlen Modul BT-D03-RF, Funk-Raumthermostat mit Glas Touch Display BT-A02-RF, Funk-Raumthermostat mit Drehregler BT-D02-RF, Funk-Raumthermostat mit LCD-Display BT-DP02-RF, Funk-Uhrenthermostat mit LCD-Display BT-D02-RF RH, Funk-Raumthermostat mit LCD-Display, Hygrostat BT-DP02-RF RH, Funk-Uhrenthermostat mit LCD-Display, Hygrostat	

3 Benutzeroberfläche / Bedienelemente



3.A. Bedeutung der LED Farben

Das Gerät BT-M6Z02-RF hat pro Zone (1) bis (6) eine zweifarbige LED und zwei zusätzliche Status LEDs.

Im Normalbetrieb:

- LEDs (1) bis (6):
 - o **Rot dauerhaft:** Heiz- oder Kühlbedarf (Wasserzirkulation auf dieser Zone)
 - o **Grün blinkend:** Funksignal Empfang vom der Zone zugeordneten Funk-Thermostat.
 - o **Rot blinkend:** Funk-Alarm, Verlust der Kommunikation zwischen Funk-Thermostat und BT-M6Z02-RF (In diesem Fall bitte die Batterien am Funk-Thermostat prüfen).
 - o **Rot blinkend alle Zonen:** Bitte prüfen, ob die Funk-Antenne korrekt angeschlossen ist.
- LED (7) Anzeige Pumpe:
 - o **Grün dauerhaft:** Ausgang Pumpe aktiviert (Pumpe EIN)
- LED (8) Anzeige Heizen / Kühlen:
 - o **Grün dauerhaft:** Kühlbetrieb (Nur in Kombination mit BT-HCM02-RF)
 - o **Rot dauerhaft:** Heizbetrieb
 - o **Rot oder Grün blinkend:** Funk-Alarm zwischen dem BT-M6Z02 RF und einem anderen Gerät als einem Thermostat

HINWEIS: Während der Funk-Konfiguration haben die LEDs (1) bis (6) eine andere Bedeutung / Funktion.

3.B. Tasten

Das Gerät BT-M6Z02-RF verfügt über 3 Bedientasten: [◀], [OK] und [▶].

Diese werden genutzt um:

- Weitere Geräte mit BT-M6Z02-RF zu verbinden: Bitte Kapitel 7 beachten
- Einen Reset auf die Werkseinstellungen vorzunehmen. Dabei werden sowohl die Einstellungen als auch die Funkverbindungen zurückgesetzt: Bitte Kapitel 7 beachten

3.C. DIP-Schalter Konfiguration

Die vordere Abdeckung des Funk-Regelverteilers abnehmen, um Zugang zu den 4 DIP-Schaltern zu schaffen. Mit diesen lassen sich erweiterte Systemeinstellungen durchführen:

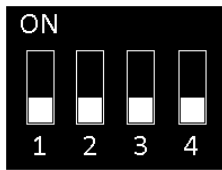

**DIP-Schalter Werkseinstellung:
alle auf Position OFF**

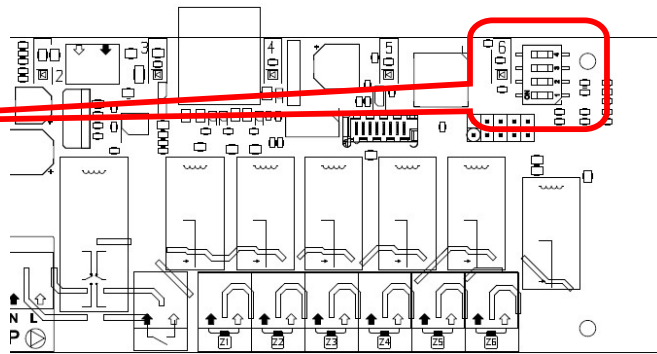

DIP-1: Konfiguration Pumpe: Lokal / Global (Pumpenrelais UND angeschlossene Pumpe)

ON (global): Ausgang Pumpe wird bei generellem Heiz-/ Kühlbedarf im System aktiviert. Funktion ist nur verfügbar, wenn entweder eine Zentraleinheit oder ein Heizen/Kühlenmodul mit entsprechenden Einstellungen vorhanden ist.

OFF (lokal): Ausgang Pumpe wird bei Heiz-/ Kühlbedarf einer Zone am BT-M6Z02-RF aktiviert

DIP-2: NO / NC Konfiguration

ON (NO): Ausgänge Stellantrieb stromlos offen (NO)

OFF (NC): Ausgänge Stellantrieb stromlos geschlossen (NC)

DIP-3: Konfiguration Pumpen Festsitzschutz

ON: Ausgang Pumpe wird einmal pro Woche aktiviert

OFF: Ausgang / Funktion nicht aktiv

DIP-4: ohne Funktion

4 ELEKTRISCHER ANSCHLUSS

4.A. Funk-Regelverteiler 230 VAC

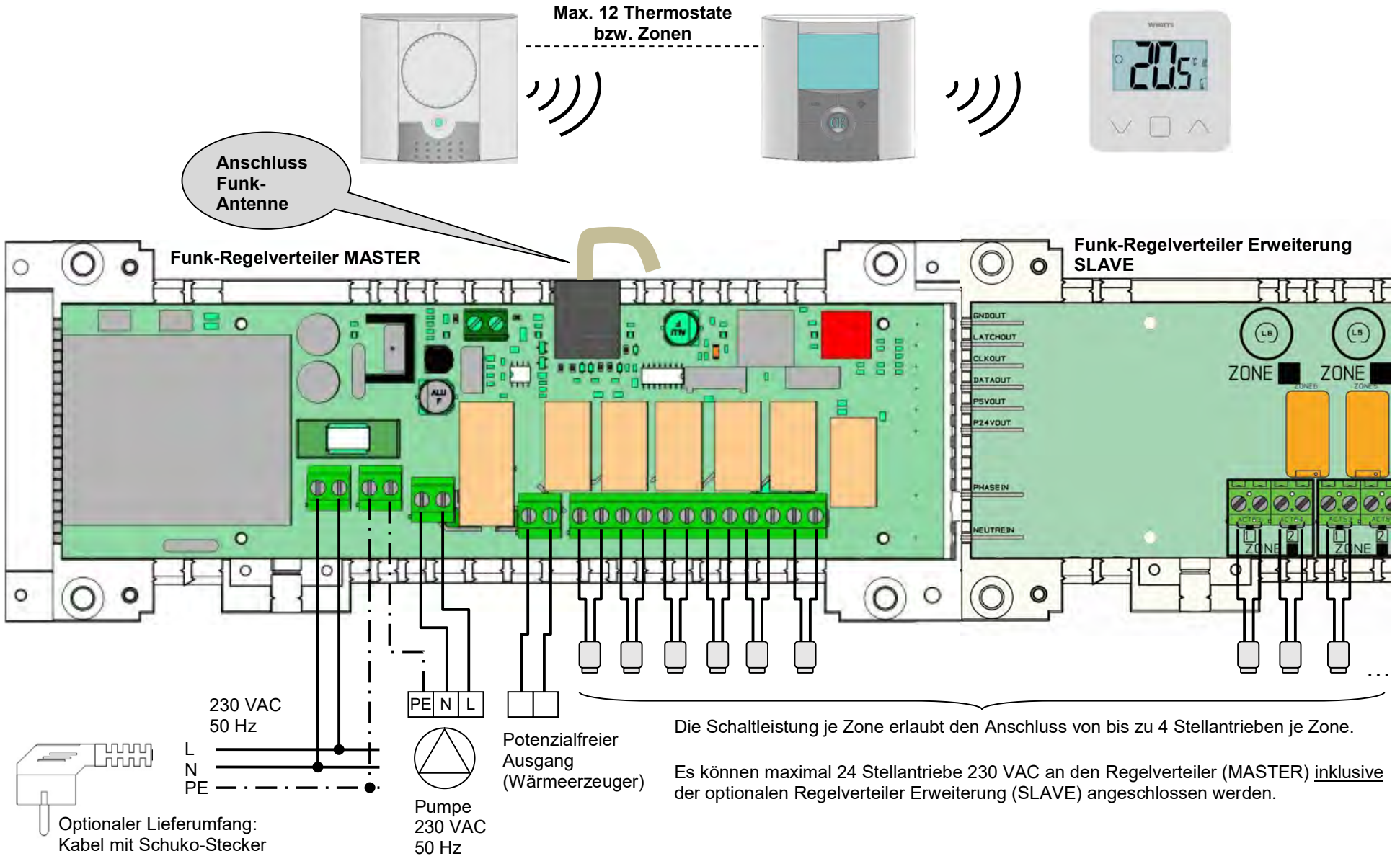

4.B. Funk-Regelverteiler 24 VAC



Anschluss Funk-Antenne

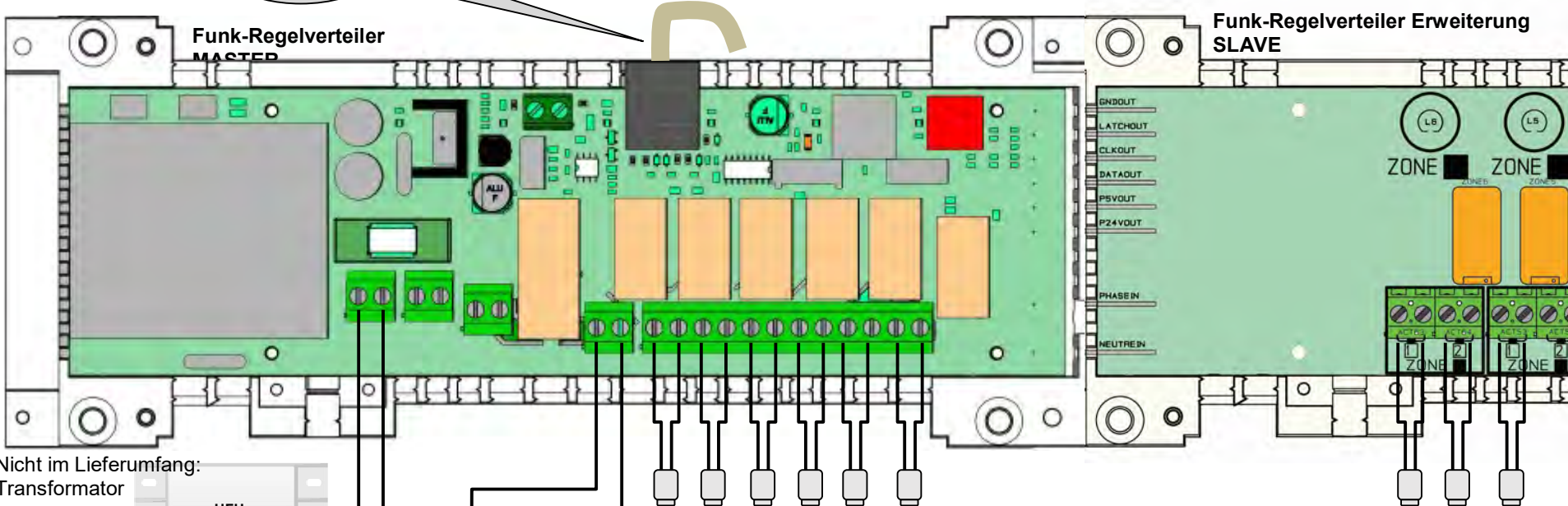

Nicht im Lieferumfang:
Transformator

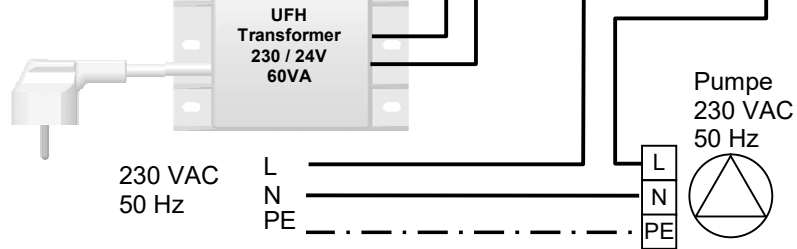

Je Zone sollten maximal 2 Stellantriebe angeschlossen werden.

Die max. Anzahl der Stellantriebe 24 VAC, welche an den Regelverteiler (MASTER) inklusive der optionalen Regelverteiler Erweiterung (SLAVE) angeschlossen werden, ist limitiert und richtet sich nach dem eingesetzten Transformator (60 VA), der Sicherung (2,5 A) und der Leistung der Stellantriebe.

5 INSTALLATION FUNK-SYSTEM



Bitte beachten Sie die Hinweise zur Montage, um einen optimalen Funkempfang zu gewährleisten und Störungen zu vermeiden.

Die Funk-Antenne muss wie folgt installiert werden:

- Außerhalb eines metallischen Verteilerkastens
- In vertikaler Position
- Mindestabstand von 50 cm zu metallischen Oberflächen bzw. vertikalen Rohrleitungen

Werden mehrere Funk-Antennen installiert (mehr als ein Funk-Regelverteiler oder bei zusätzlicher Verwendung des Heizen / Kühlen Moduls BT-HCM02-RF), müssen die Antennen in einem Abstand von min. 80 cm platziert werden, um gegenseitige Störung zu vermeiden.

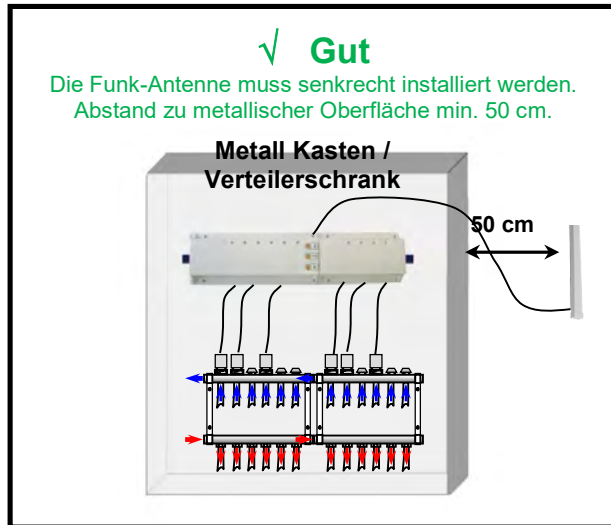

6 SYSTEM OPTIONEN:

Weitere Informationen zu den verschiedenen Möglichkeiten die Produkte zu kombinieren finden Sie im Handbuch **WATTS® Vision® System Übersicht** (www.wattswater.de).

Es wird in zwei Arten der Installation unterschieden: Ohne / Mit Zentraleinheit BT-CT02-RF.

Wenn Sie eine Zentraleinheit BT-CT02-RF in Ihrer Installation haben, springen Sie zu Kapitel 6.B.

6.A. Installation ohne Zentraleinheit BT-CT02-RF

Bei dieser Installation existieren 2 Varianten:

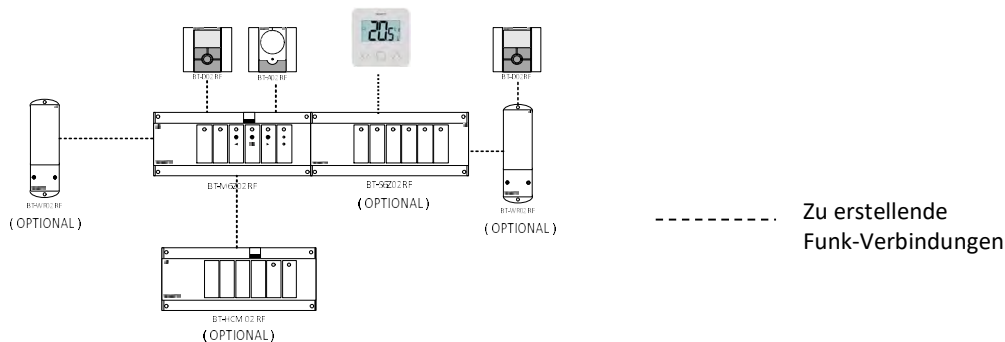

- 1- Installation "Standalone", Typische Installationen:
 - a. Lediglich ein Funk-Regelverteiler BT-M6Z02-RF (ggf. mit Erweiterung BT-S.Z02-RF)
 - b. Mehrere Funk-Regelverteiler BT-M6Z02-RF (ggf. mit Erweiterung BT-S.Z02-RF) und lokaler Pumpensteuerung
- 2- Installation "Zentrales Management": In diesem Fall gibt es mehrere BT-M6Z02-RF, die zusammen kommunizieren müssen, um Pumpen sowie Heizen / Kühlen Management korrekt zu betreiben.
 - a. Mehrere Funk-Regelverteiler BT-M6Z02-RF (ggf. mit Erweiterung BT-S.Z02-RF) und globaler Pumpensteuerung
 - b. Mehrere Funk-Regelverteiler BT-M6Z02-RF (ggf. mit Erweiterung BT-S.Z02-RF) und mindestens ein Heizen / Kühlen Modul BT-HCM02-RF

6.A.1 Standalone Installation - Beispiel einer "Standalone" Installation

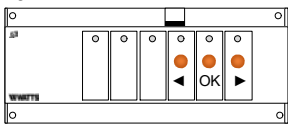
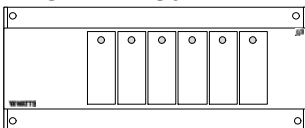
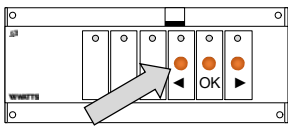
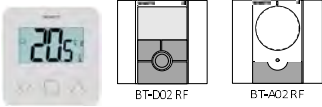
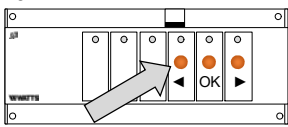
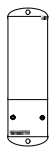
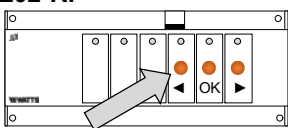
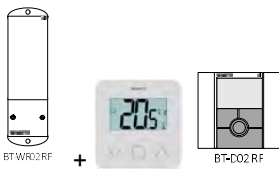
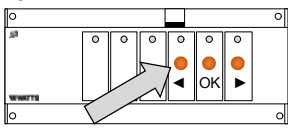
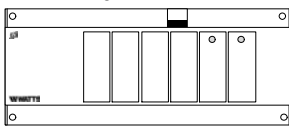

Diese Elemente müssen verbunden werden. Bitte die Reihenfolge der Funk-Zuordnung einhalten.

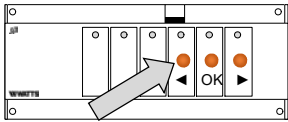
Funk-Zuordnung (Paarung) Element 1	Funk-Zuordnung (Paarung) Element 2	Kommentar
<p>BT-M6Z02-RF</p>  <p>BT-M6Z02 RF</p>	<p>BT-S4Z / BT-S6Z</p>  <p>BT-S6Z02 RF</p>	<p>Keine Funk-Zuordnung notwendig. Lediglich BT-M6Z02-RF Master und BT-S.Z02-RF Slave im spannungslosen Zustand zusammenstecken.</p>
<p>BT-M6Z02-RF</p>  <p>BT-M6Z02 RF</p> <p>[OK] Taste 5 Sekunden gedrückt halten; die LED der Zone 1 blinkt. Mit [◀] oder [▶] wechseln Sie die Zone; Mit [OK] die Zone aus- bzw. abwählen. Eine ausgewählte Zone leuchtet rot.</p> <p>Hinweis: Zum Verlassen [OK] Taste 5 Sekunden gedrückt halten.</p>	<p>BT-D.02/03-RF / BT-A02-RF</p>  <p>BT-D02 RF BT-A02 RF</p> <p>Funk-Thermostat: Aktivieren Sie den "rF init" Modus am Funk-Thermostat, welchen Sie mit der ausgewählten Zone/n paaren wollen. (Näheres entnehmen Sie der Bedienungsanleitung des Funk-Thermostats).</p>	<p>Nach erfolgreicher Paarung leuchtet die entsprechende Zone am Funk-Regelverteiler grün.</p> <p>Der Funk-Thermostat sollte den "rF init" Modus verlassen haben.</p>
<p>BT-M6Z02-RF</p>  <p>BT-M6Z02 RF</p> <p>[◀] Taste 5 Sekunden gedrückt halten; alle Zonen LEDs blinken grün. Das Gerät wartet auf ein Paarungssignal.</p> <p>Hinweis: Zum Verlassen [◀] Taste 5 Sekunden gedrückt halten.</p>	<p>BT-WR02-RF</p>  <p>BT-WR02 RF</p> <p>Aktivieren Sie den Modus Funk-Konfiguration am Funk-Empfänger. (Näheres entnehmen Sie der Bedienungsanleitung des Funk-Empfängers).</p>	<p>In dieser Konfiguration arbeitet BT-WR02-RF als Fernsteuerung einer Pumpe oder Wärmeerzeugers: Besteht Anforderung am BT-M6Z02-RF wird der Ausgang aktiviert. Nach erfolgreicher Paarung wechseln BT-M6Z02-RF und BT-WR02-RF in den normalen Modus. BEMERKUNG: Anstelle von BT-WR02-RF kann in gleicher Weise auch ein BT-FR02-RF oder ein BT-PR02-RF zugeordnet werden.</p>
<p>BT-M6Z02-RF</p>  <p>BT-M6Z02 RF</p> <p>[◀] Taste 5 Sekunden gedrückt halten; alle Zonen LEDs blinken grün. Das Gerät wartet auf ein Paarungssignal.</p> <p>Hinweis: Zum Verlassen [◀] Taste 5 Sekunden gedrückt halten.</p>	<p>BT-WR02-RF + BT-D02/03-RF</p>  <p>BT-WR02 RF + BT-D02 RF</p> <p>Zuerst BT-WR02-RF mit dem Funk-Thermostat paaren. Danach aktivieren Sie den Modus Funk-Konfiguration am Funk-Empfänger.</p>	<p>In dieser Konfiguration wird BT-WR02-RF als zusätzliche Zone verwendet. Nach erfolgreicher Paarung wechseln BT-M6Z02-RF und BT-WR02-RF in den normalen Modus. BEMERKUNG 1: Anstelle von BT-WR02-RF kann in gleicher Weise auch ein BT-FR02-RF oder ein BT-PR02-RF zugeordnet werden. BEMERKUNG 2: Diese Konfiguration ist nur in einer Heizungsanlage möglich (keine Kühlung).</p>
<p>BT-M6Z02-RF</p>  <p>BT-M6Z02 RF</p> <p>[◀] Taste 5 Sekunden gedrückt halten; alle Zonen LEDs blinken grün. Das Gerät wartet auf ein Paarungssignal.</p> <p>Hinweis: Zum Verlassen [◀] Taste 5 Sekunden gedrückt halten.</p>	<p>BT-HCM02-RF</p>  <p>BT-HCM02 RF</p> <p>Aktivieren Sie den Modus Funk-Konfiguration am Heizen / Kühlen Modul.</p>	<p>Nach erfolgreicher Paarung wechseln BT-M6Z02-RF und BT-HCM02-RF gleichzeitig in den normalen Modus.</p>

<p>BT-M6Z02-RF</p>  <p>BT-M6Z02 RF</p> <p>[◀] Taste 5 Sekunden gedrückt halten; alle Zonen LEDs blinken grün. Das Gerät wartet auf ein Paarungssignal. Hinweis: Zum Verlassen [◀] Taste 5 Sekunden gedrückt halten.</p>	<p>BT-RPT02-RF</p>  <p>Taste 3 Sekunden gedrückt halten, um den Repeater in den Modus Funk-Paarung (Konfiguration) zu bringen</p>	<p>Bei erfolgreicher Funk-Paarung kehrt der BT-M6Z02-RF in den normalen Betrieb zurück und die LED am Repeater leuchtet dauerhaft grün.</p>
--	--	---

6.A.2 Installation "Zentrales Management"

In dieser Konfiguration übernimmt ein Funk-Regelverteiler BT-M6Z02-RF die Funktion eines Haupt-Reglers (weiter bezeichnet als „Main“ BT-M6Z02-RF) zum zentralen Informationsaustausch von bis zu 3 weiteren Funk-Regelverteiler BT-M6Z02-RF (weiter bezeichnet als „Sub“ BT-M6Z02-RF).

Aufgabe des „Main“ BT-M6Z02-RF:

- Weiterleitung des Heiz- und Kühlsignals an das System
- Handhabung der Anforderung Wärmeerzeuger / globale Pumpensteuerung für das ganze System

Wenn in der Anlage ein Heizen / Kühlen Modul BT-HCM02-RF vorhanden ist, muss dieses mit dem „Main“ BT-M6Z02-RF verbunden sein.

Beispiel einer Installation "Zentrales Management"

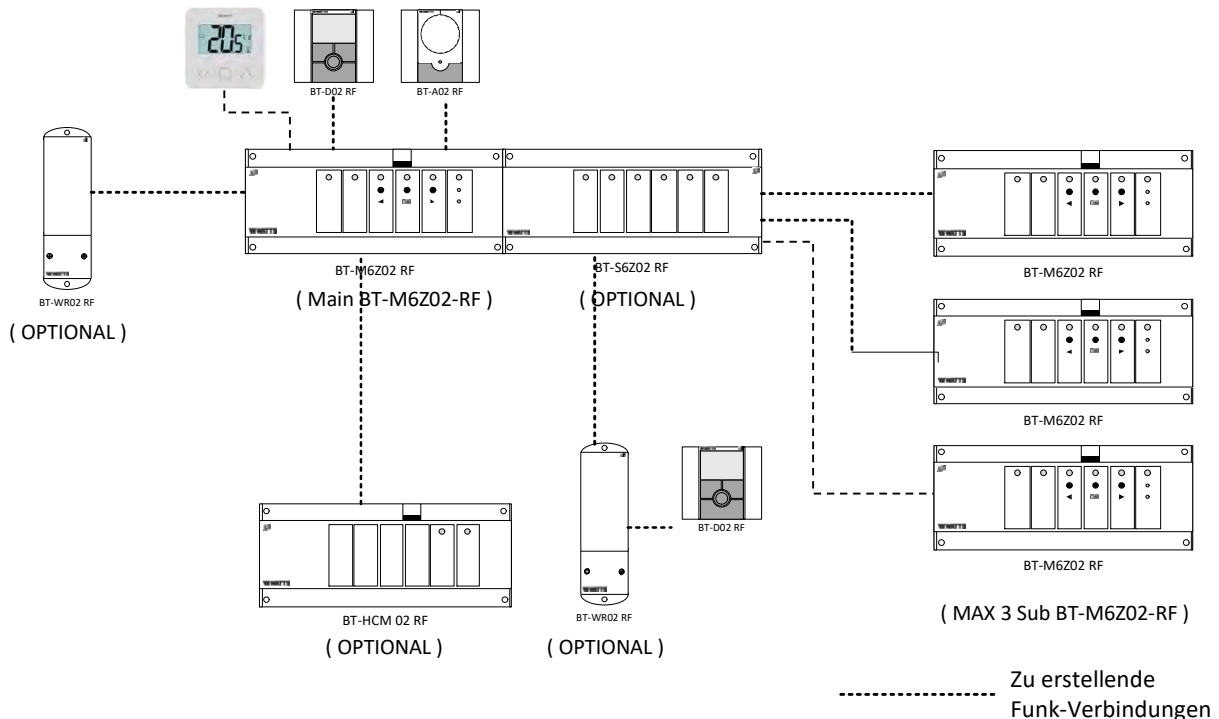

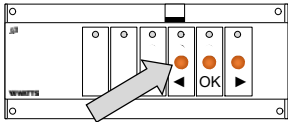
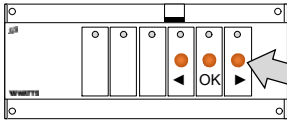
Funk-Zuordnung (Paarung) Element 1	Funk-Zuordnung (Paarung) Element 2	Kommentar
<p>Führen Sie zunächst die Funk-Zuordnung wie unter „6.A.1 Standalone Installation“ beschrieben durch. Danach paaren Sie alle „Sub“ BT-M6Z02-RF mit dem „Main“ BT-M6Z02-RF</p>		
<p>« Main » BT-M6Z02-RF</p>  <p>BT-M6Z02 RF</p> <p>[◀] Taste 5 Sekunden gedrückt halten; alle Zonen LEDs blinken grün. Das Gerät wartet auf ein Paarungssignal. Hinweis: Zum Verlassen [◀] Taste 5 Sekunden gedrückt halten.</p>	<p>« Sub » BT-M6Z02-RF</p>  <p>BT-M6Z02 RF</p> <p>[▶] Taste 5 Sekunden gedrückt halten; alle Zonen LEDs sollten rot blinken. Das Gerät wartet auf ein Paarungssignal. Hinweis: Zum Verlassen [▶] Taste 5 Sekunden gedrückt halten.</p>	<p>Nach erfolgreicher Paarung wechseln die beiden BT-M6Z02-RF in den normalen Modus.</p>

6.B. Installation mit Zentraleinheit BT-CT02-RF

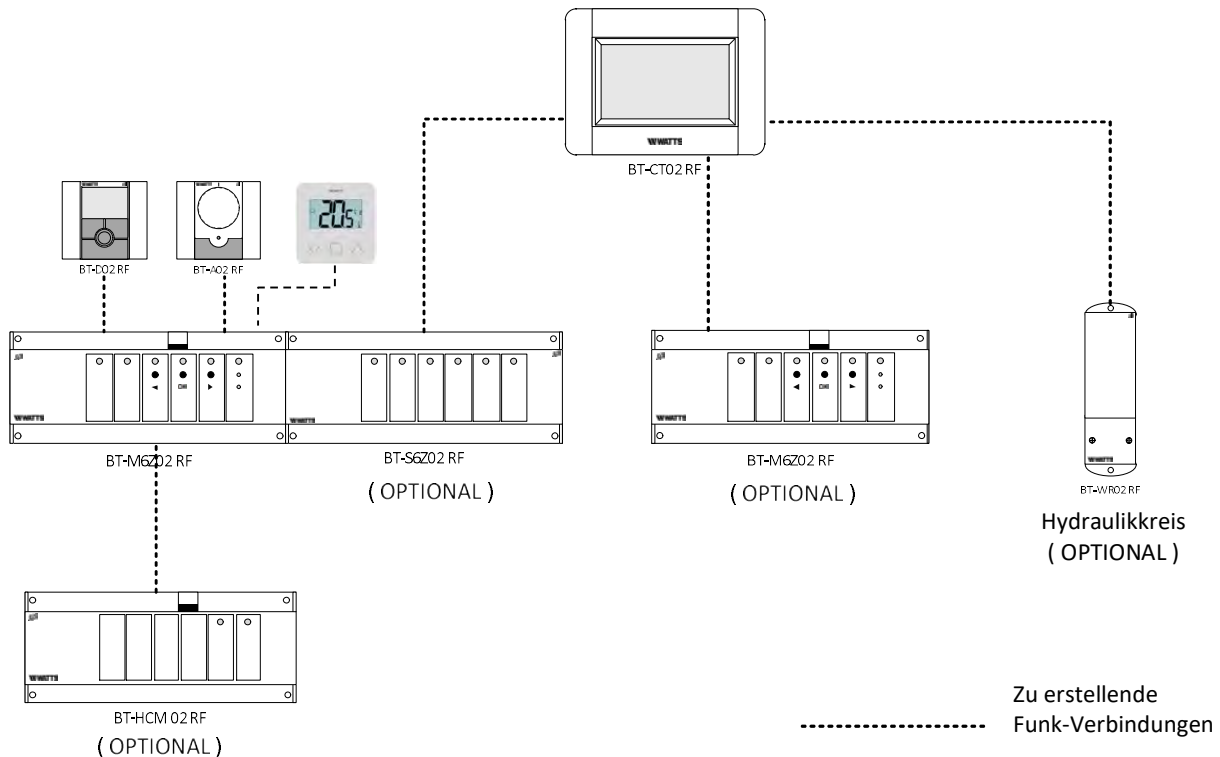

Wenn in der Anlage eine Zentraleinheit BT-CT02-RF vorhanden ist, wird alles über diese zentralisiert.

Beispiel einer Installation "Zentrales Management"

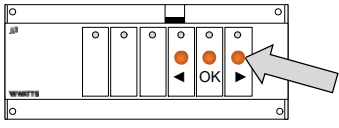
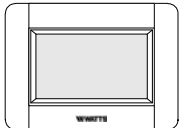
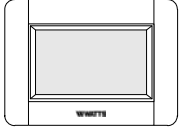

Bitte bei dieser Konfiguration die Reihenfolge der Funk-Zuordnung einhalten:

Funk-Zuordnung (Paarung) Element 1	Funk-Zuordnung (Paarung) Element 2	Kommentar
<p>BT-M6Z02-RF</p> <p>[OK] Taste 5 Sekunden gedrückt halten; die LED der Zone 1 blinkt. Mit [◀] oder [▶] wechseln Sie die Zone; Mit [OK] die Zone aus- bzw. abwählen. Eine ausgewählte Zone leuchtet rot. Hinweis: Zum Verlassen [OK] Taste 5 Sekunden gedrückt halten.</p>	<p>BT-D.02/03-RF / BT-A02-RF</p> <p>Funk-Thermostat: Aktivieren Sie den "rF init" Modus am Funk-Thermostat, welchen Sie mit der ausgewählten Zone/n paaren wollen. (Näheres entnehmen Sie der Bedienungsanleitung des Funk-Thermostats).</p>	<p>Nach erfolgreicher Paarung leuchtet die entsprechende Zone am Funk-Regelverteiler grün. Der Funk-Thermostat sollte den "rF init" Modus verlassen haben.</p>
<p>BT-M6Z02-RF</p> <p>[◀] Taste 5 Sekunden gedrückt halten; alle Zonen LEDs blinken grün. Das Gerät wartet auf ein Paarungssignal. Hinweis: Zum Verlassen [◀] Taste 5 Sekunden gedrückt halten.</p>	<p>BT-HCM02-RF</p> <p>Aktivieren Sie den Modus Funk-Konfiguration am Heizen / Kühlen Modul.</p>	<p>Nach erfolgreicher Paarung wechseln BT-M6Z02-RF und BT-HCM02-RF gleichzeitig in den normalen Modus. BEMERKUNG: Lediglich ein BT-HCM02-RF in einer Installation möglich.</p>

<p style="text-align: center;">BT-M6Z02-RF</p>  <p style="text-align: center;">BT-M6Z02 RF</p> <p>[▶] Taste 5 Sekunden gedrückt halten; alle Zonen LEDs sollten rot blinken. Das Gerät wartet auf ein Paarungssignal.</p> <p>Hinweis: Zum Verlassen [▶] Taste 5 Sekunden gedrückt halten.</p>	<p style="text-align: center;">BT-CT02-RF</p>  <p style="text-align: center;">BT-CT02 RF</p> <p>Paaren Sie die Zentraleinheit als normale Zone.</p>	
<p style="text-align: center;">BT-CT02-RF</p>  <p style="text-align: center;">BT-CT02 RF</p> <p>Paarung als „Hydraulikkreis“</p>	<p style="text-align: center;">BT-WR02-RF</p>  <p style="text-align: center;">BT-WR02 RF</p> <p>Aktivieren Sie den Modus Funk-Konfiguration am Funk-Empfänger. (Näheres entnehmen Sie der Bedienungsanleitung des Funk-Empfängers).</p>	<p>In dieser Konfiguration wird der Funk-Empfänger BT-WR02-RF zur Steuerung eines Hydraulikkreises verwendet.</p> <p>Weitere Informationen finden Sie in der Bedienungsanleitung der Zentraleinheit BT-CT02-RF.</p>

BITTE BEACHTEN! Paaren Sie den Funk-Regelverteiler BT-M6Z02-RF mit der Zentraleinheit BT-CT02-RF erst nachdem ALLE Funk-Thermostate mit BT-M6Z02-RF verbunden sind.

7 SONDERFUNKTIONEN

Feuchte Management

Diese Funktion ist bei den Funk-Hygrostaten (BT-D02RF RH und BT-DP02RF RH) verfügbar. Bitte beachten Sie die Bedienungsanleitung des Funk-Hygrostats, um die Parameter korrekt einzustellen.

- Wenn ein Feuchte Ausfall (durch Unterschreiten des Taupunkt Grenzwerts) vorliegt, wird die Kühlung auf dieser Zone ausgesetzt (stoppt den Durchfluss im Kühlkreis der Zone).
- Wenn in der Anlage ein Heizen / Kühlen Modul BT-HCM02-RF vorhanden und ein Luftentfeuchter aufgeschaltet ist, wird dieser aktiviert.

Pumpen Verzögerung (nicht konfigurierbar)

Zur Vermeidung von Pumpenschäden und Geräuschen im Hydraulikkreislauf (Heiz-/Kühlkreise) erfolgt das Einschalten der Pumpe erst ca. 2 Minuten nachdem eine Anforderung an wenigstens einer Zone besteht. Diese Verzögerung ermöglicht das Öffnen des Stellantriebs vor Einschalten der Pumpe.

Ventil Festsitzschutz (nicht konfigurierbar)

Um ein Festsitzen der Ventile zu verhindern, wird jedes Ventil automatisch einmal pro Woche für 2 Minuten aktiviert.

Werkseinstellung Reset

Das System kann auf Werkseinstellung zurückgesetzt werden. Hierbei werden alle Konfigurationen am Regler gelöscht. Ebenso wird die Paarung des Funk-Regelverteilers mit den verbundenen Geräten aufgehoben.

Im Normalbetrieb erfolgt, durch Drücken und Halten der Tasten [◀] und [▶] für 5 Sekunden, die Rückstellung auf die Werkseinstellungen.

1 GUIDA UTENTE

La scatola di connessione BT-M6Z02-RF è stata appositamente studiata per controllare l'impianto di riscaldamento a pavimento e impianti di raffreddamento.

Può gestire attuatori normalmente chiusi (NC) o normalmente aperti (NO).

La scatola di connessione è stata concepita con sei attuatori in uscita, ma è possibile averne anche 10 o 12 con un'estensione.

Il BT-M6Z02-RF funziona con termostati collegati in RF; può avere fino a 12 termostati collegati a esso e gestire 12 regolazioni indipendenti in parallelo.

Funziona con tutti i termostati della gamma BT02 RF / BT03 RF.

Il BT-M6Z02-RF è dotato di speciali caratteristiche quali:

- Uscita per pompa o caldaia (con o senza cavo con BT-WR02-RF).
- Gestione dell'umidità (tramite BT-D02-RF RH e BT-DP02-RF RH).
- Gestione del segnale di riscaldamento e raffreddamento in ingresso (tramite BT-HCM02-RF).
- Uscita per deumidificatore (tramite BT-HCM02-RF).
- Collegamento con la centralina BT-CT02-RF.

2 CARATTERISTICHE TECNICHE

	BT-M6Z02-RF 230 V	BT-M6Z02-RF 24 V
Temperatura d'esercizio	Da 0 °C a 50 °C	
Caratteristiche della regolazione	Regolazione proporzionale-integrale o regolazione dell'isteresi. La regolazione è definita dal termostato collegato al canale (vedi foglio di istruzioni del termostato).	
Tensione d'alimentazione	230 VCA +-10% 50 Hz	24 VCA +-10% 50 Hz
Uscite: Pompa o accessori Attuatori	Relè => 5 A/250 VCA (contatto pulito) Relè => 5 A/230 VCA (L, N) Per una facile installazione si consiglia un massimo di quattro attuatori per zona.	Relè => 5 A/250 VCA (contatto libero) Triac => 3 A/24 VCA Il numero totale di attuatori è limitato dal trasformatore (60 VA), dal fusibile (2,5 A) e dalla potenza degli attuatori.
Frequenza radio	868,3 MHz, <10 mW. Funzionamento a una distanza di circa 180 m in spazi aperti. Funzionamento a una distanza di circa 50 m in ambienti residenziali.	
Direttive CE Il prodotto è stato progettato in conformità alle Direttive europee	Direttiva 2001/95/CE relativa alla sicurezza generale dei prodotti Direttiva sulla bassa tensione 2014/35/UE Direttiva 2014/53/UE sulle apparecchiature radio Direttiva RoHS 2011/65/UE Direttiva EMC 2014/30/UE	
Protezione	IP 30	
Compatibilità	Con BT S4Z02 RF: 10 zone => 1 Master 6 zone + 1 Slave 4 zone Con BT S6Z02 RF: 12 zone => 1 Master 6 zone + 1 Slave 6 zone BT-WR02-RF, BT-WR02 FC RF BT-PR02-RF BT-FR02-RF BT-CT02-RF Ripetitore RF BT-A02 RF BT-D02 RF, BT-D02 RH RF BT-DP02 RF, BT-DP02 RH RF BT-D03 RF	

3 Interfaccia utente



3.A. Significato dei colori dei LED

Sul BT-M6Z02-RF è presente un LED bicolore per le zone da (1) a (6) e due ulteriori LED di stato.

Nella modalità operativa Normale

- Da (1) a (6):
 - o **Luce rossa fissa:** indicatore di richiesta di riscaldamento o raffreddamento (circolazione dell'acqua in questa zona).
 - o **Luce verde da spenta a lampeggiante:** segnale RF ricevuto dal termostato assegnato a questa zona.
 - o **Luce rossa da fissa a lampeggiante:** allarme RF, persa comunicazione tra il termostato e il BT-M6Z02-RF. In tal caso controllare le batterie sul termostato.
 - o **Luce rossa da spenta a lampeggiante in tutte le zone:** controllare il collegamento dell'antenna RF.
- (7): Indicatore della pompa
 - o **Verde** quando l'uscita della pompa è attiva.
- (8): Indicatore di riscaldamento e raffreddamento
 - o **Verde** per raffreddamento
 - o **Rossa** per riscaldamento
 - o **Lampeggiante rosso o verde:** Allarme RF tra BT-M6Z02 RF e qualsiasi dispositivo diverso da un termostato

In modalità di collegamento RF (RF Link) gli indicatori LED da (1) a (6) hanno un diverso significato. Fare riferimento alla sezione 6.

3.B. Pulsanti

Sul BT-M6Z02-RF vi sono tre pulsanti: "<", "OK" e ">".

Vengono usati per:

- Collegare elementi al BT-M6Z02-RF: fare riferimento alla sezione 6
- Resettare il dispositivo alle impostazioni di fabbrica (resettare tutte le configurazioni e tutti i collegamenti RF): fare riferimento alla sezione 7

3.C. Configurazione DIP switch

Quando si svita la parte frontale del BT-M6Z02-RF, si può accedere a quattro interruttori usati per la configurazione avanzata:

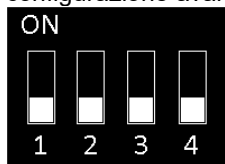

La posizione predefinita è OFF per tutti e quattro.

Interruttore 1: configurazione della pompa locale/generale (uscita della pompa E dispositivo della pompa in remoto).

ON (generale): il BT-M6Z02-RF attiva la pompa in caso di richiesta di riscaldamento o raffreddamento nell'impianto.

OFF (locale): il BT-M6Z02-RF attiva la pompa in caso di richiesta sul BT-M6Z02-RF.

Interruttore 2: configurazione NO/NC.

ON (NO): uscite (attuatori) normalmente aperte.

OFF (NC): uscite (attuatori) normalmente chiuse.

Interruttore 3: configurazione movimentazione della pompa.

ON: Una vez a la semana, se activa la salida de la bomba

OFF: nessuna azione sull'uscita della pompa.

Interruttore 4: nessuna funzione associata.

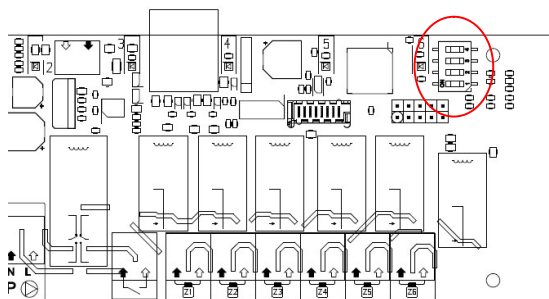

4 SCHEMA ELETTRICO

4.1 SCHEMA ELETTRICO 230 V

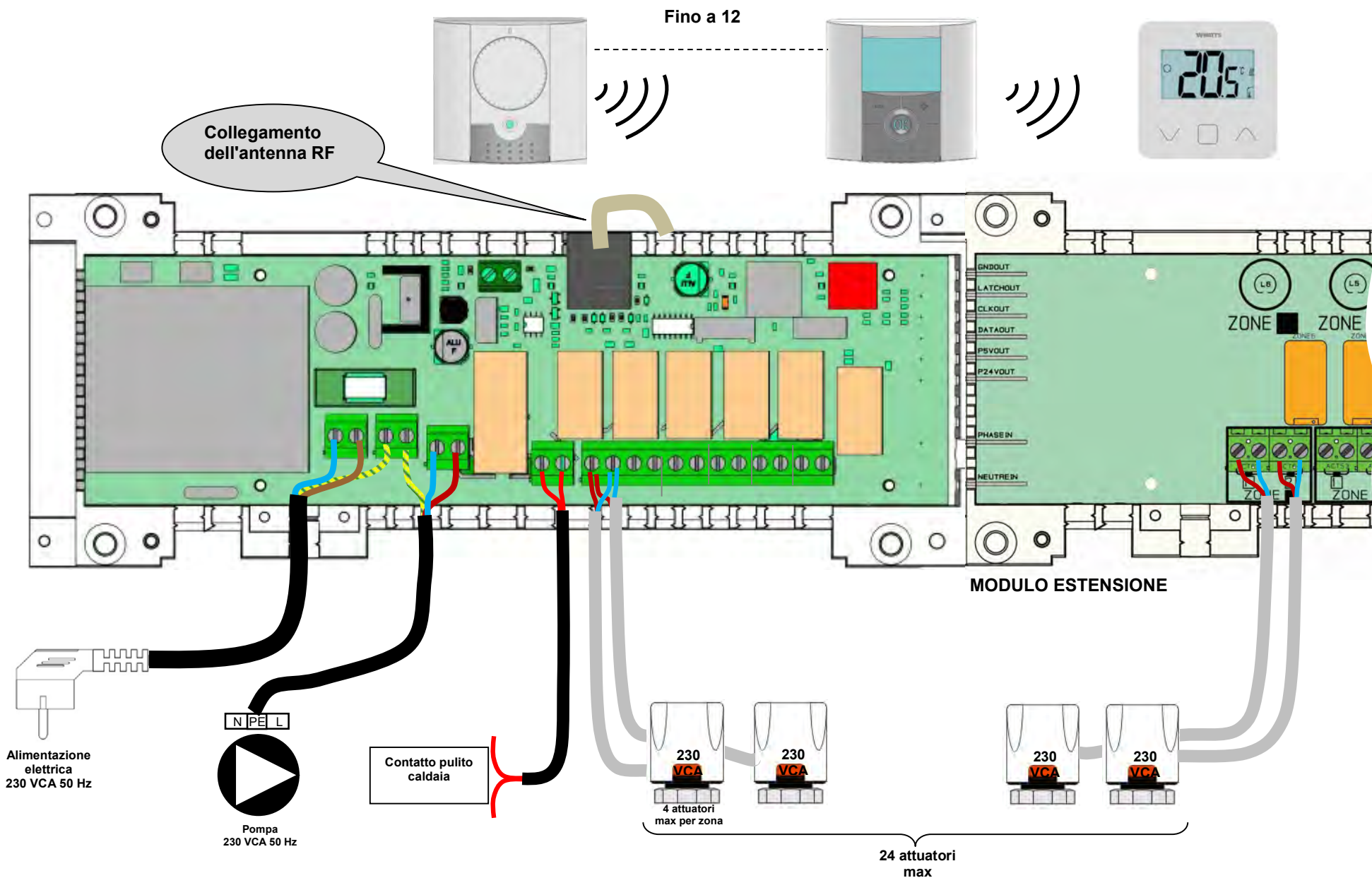

4.2 SCHEMA ELETTRICO 24 V

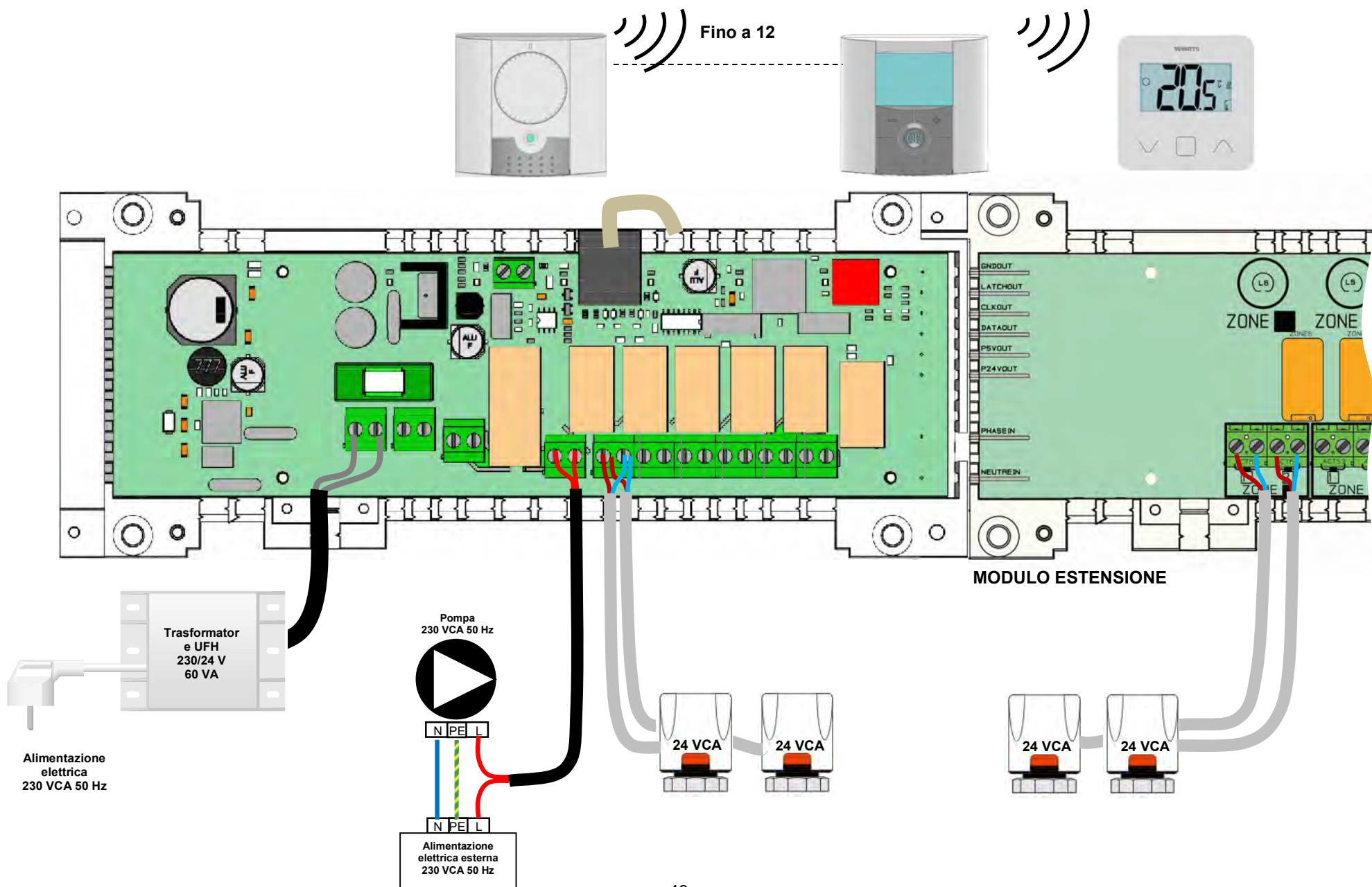

5 COME INSTALLARE CORRETTAMENTE L'IMPIANTO RF

 **Rispettare le istruzioni di montaggio per ottimizzare la ricezione ed evitare malfunzionamenti.**

L'antenna deve essere collocata:

- fuori dalla scatola metallica;
- in posizione verticale;
- ad almeno 50 cm da parti metalliche.

Se si hanno diverse antenne (diversi BT-M6Z02RF/BT-HCM02-RF nello stesso posto), devono essere posizionati ad almeno 80 cm l'uno dall'altro.

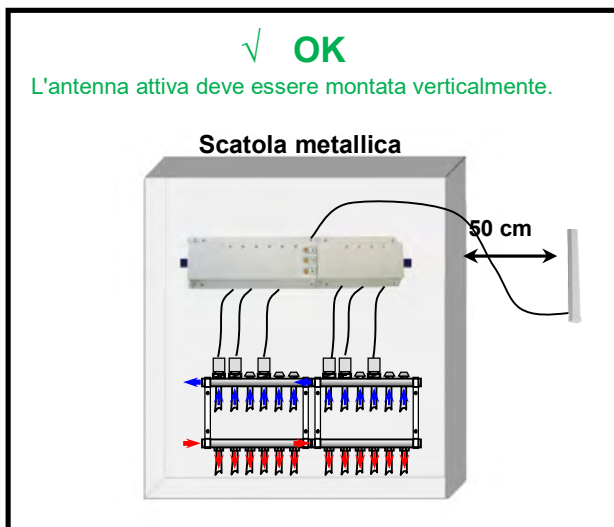

6 TIPOLOGIE POSSIBILI DI IMPIANTI:

Per maggiori informazioni sulle diverse possibilità, fare riferimento al manuale di configurazione del sistema (www.wattselectronics.com).

Si distinguono due tipi di impianti. Se si ha un BT-CT02-RF nell'impianto, andare a 6.B

6.A. Impianto senza controllore touchscreen BT-CT02-RF

In quest'impianto ci sono due sottotipologie:

- 1- Impianto "autonomo". Installazioni tipiche:
 - a. Solo un BT-M6Z02-RF
 - b. Diversi BT-M6Z02-RF con gestione della pompa locale

- 2- Impianto "a gestione centralizzata": in questo caso, vi sono diversi BT-M6Z02-RF che devono comunicare gli uni con gli altri per comandare correttamente la pompa con il segnale di riscaldamento/raffreddamento.
 - a. Diversi BT-M6Z02-RF con gestione della pompa generale
 - b. Diversi BT-M6Z02-RF e un solo BT-HCM02-RF

6.A.1 Impianto autonomo

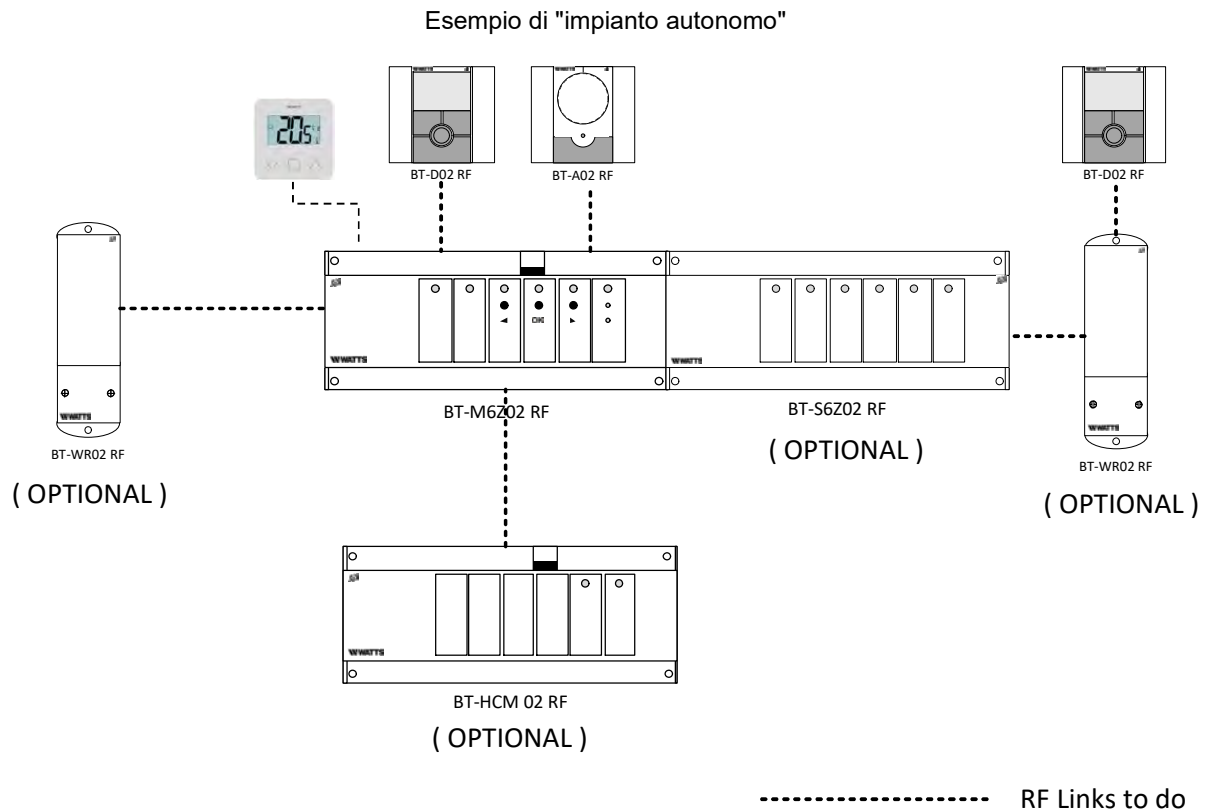

Tutti questi elementi devono essere collegati tra loro. La procedura di collegamento RF può essere eseguita in quest'ordine:

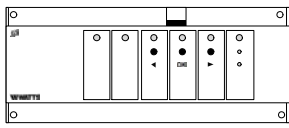
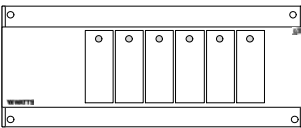
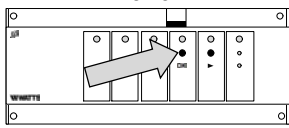
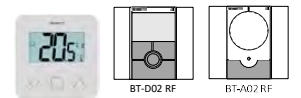
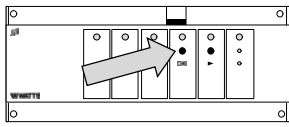
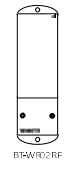
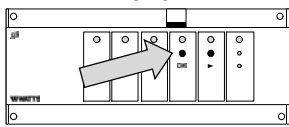
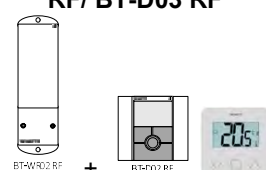
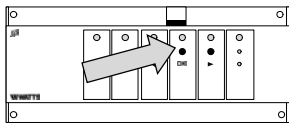
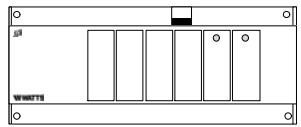
Elemento 1 da collegare	Elemento 2 da collegare	Commenti
<p align="center">BT-M6Z02-RF</p>  <p align="center">BT-M6Z02.RF</p>	<p align="center">BT-S4Z/BT-S6Z</p>  <p align="center">BT-S6Z02.RF</p>	<p>Non occorre collegarli, basta montare l'S4Z o l'S6Z con il BT-M6Z02-RF (entrambi scollegati dalla tensione) e poi si possono selezionare le zone.</p>
<p align="center">BT-M6Z02-RF</p>  <p align="center">BT-M6Z02.RF</p> <p>Premere OK per 5 secondi. Il primo canale LED deve lampeggiare. Scegliere i canali con < e > e selezionare/deselezionare la zona con OK. Quando si seleziona una zona, questa diventa rossa. Nota: per uscire, premere OK per 5 secondi.</p>	<p align="center">BT-D03 RF / BT-D(P)02-RF/BT-A02-RF</p>  <p>Termostati: Mettere il prodotto in modalità Collegamento RF (fare riferimento al relativo manuale di istruzioni).</p>	<p>Se è stato effettuato il collegamento, i LED dei canali selezionati sul BT-M6Z02 RF devono diventare verdi e i termostati devono uscire dalla modalità Collegamento RF.</p>
<p align="center">BT-M6Z02-RF</p>  <p align="center">BT-M6Z02.RF</p> <p>Premere < per 5 secondi. Tutti i canali devono diventare verdi. Il prodotto è in attesa del collegamento. Nota: per uscire, premere < per 5 secondi.</p>	<p align="center">BT-WR02-RF</p>  <p align="center">BT-WR02.RF</p> <p>Mettere il prodotto in modalità Collegamento RF (fare riferimento al relativo manuale di istruzioni).</p>	<p>In questa configurazione, il BT-WR02-RF è usato come dispositivo remoto di pompaggio o caldaia: se c'è una richiesta da parte del BT-M6Z02-RF, il dispositivo comanderà l'uscita. Quando il collegamento è stato effettuato, il BT-M6Z02-RF e il BT-WR02-RF ritornano alla modalità Normale. ATTENZIONE: invece del BT-WR02-RF, è possibile usare anche il BT-FR02-RF ed il BT-PR02-RF.</p>
<p align="center">BT-M6Z02-RF</p>  <p align="center">BT-M6Z02.RF</p> <p>Premere < per 5 secondi. Tutti i canali devono diventare verdi. Il prodotto è in attesa del collegamento. Nota: per uscire, premere < per 5 secondi.</p>	<p align="center">BT-WR02-RF + BT-D02-RF/ BT-D03 RF</p>  <p>Il BT-WR02-RF deve prima essere collegato al termostato. Mettere il BT-WR02-RF in modalità Collegamento RF.</p>	<p>In questa configurazione, il BT-WR02-RF è usato come zona aggiuntiva. Quando il collegamento è stato effettuato, il BT-M6Z02-RF e il BT-WR02-RF ritornano alla modalità Normale. ATTENZIONE 1: invece del BT-WR02-RF, è possibile usare anche il BT-FR02-RF ed il BT-PR02-RF. ATTENZIONE 2: questa configurazione è possibile solo in impianti di riscaldamento, non di raffreddamento.</p>
<p align="center">BT-M6Z02-RF</p>  <p align="center">BT-M6Z02.RF</p> <p>Premere < per 5 secondi. Tutti i canali devono diventare verdi. Il prodotto è in attesa del collegamento. Nota: per uscire, premere < per 5 secondi.</p>	<p align="center">BT-HCM02-RF</p>  <p align="center">BT-HCM02.RF</p> <p>Mettere il prodotto in modalità Collegamento RF (fare riferimento al relativo manuale di istruzioni).</p>	<p>Quando il collegamento è stato effettuato, il BT-M6Z02-RF ed il BT-HCM02-RF ritornano contemporaneamente alla modalità Normale.</p>

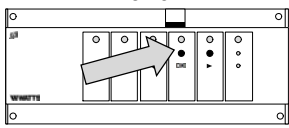
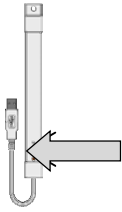
<p>BT-M6Z02-RF</p>  <p>BT-M6Z02 RF</p> <p>Premere < per 5 secondi. Tutti i canali devono diventare verdi. Il prodotto è in attesa del collegamento.</p> <p>Nota: per uscire, premere < per 5 secondi.</p>	<p>Mettere il ripetitore di segnale RF in modalità Collegamento RF (premere il pulsante per oltre 3 secondi)</p> 	<p>Quando il collegamento è stato effettuato, il BT-M6Z02-RF ritorna alla normale modalità e il led sul ripetitore è di luce verde fissa.</p>
---	--	---

6.A.2 Impianto centralizzato

In questa configurazione, un BT-M6Z02-RF, detto BT-M6Z02-RF "principale", centralizzerà le informazioni dell'altro BT-M6Z02-RF, detto BT-M6Z02-RF "subordinato".

Ha il compito di:

- Propagare il segnale di riscaldamento/raffreddamento al sistema.
- Gestire la caldaia/pompa generale di tutto l'impianto.

Se nell'impianto c'è un BT-HCM02-RF, DEVE essere collegato al BT-M6Z02-RF "principale".

Esempio di "impianto centralizzato"

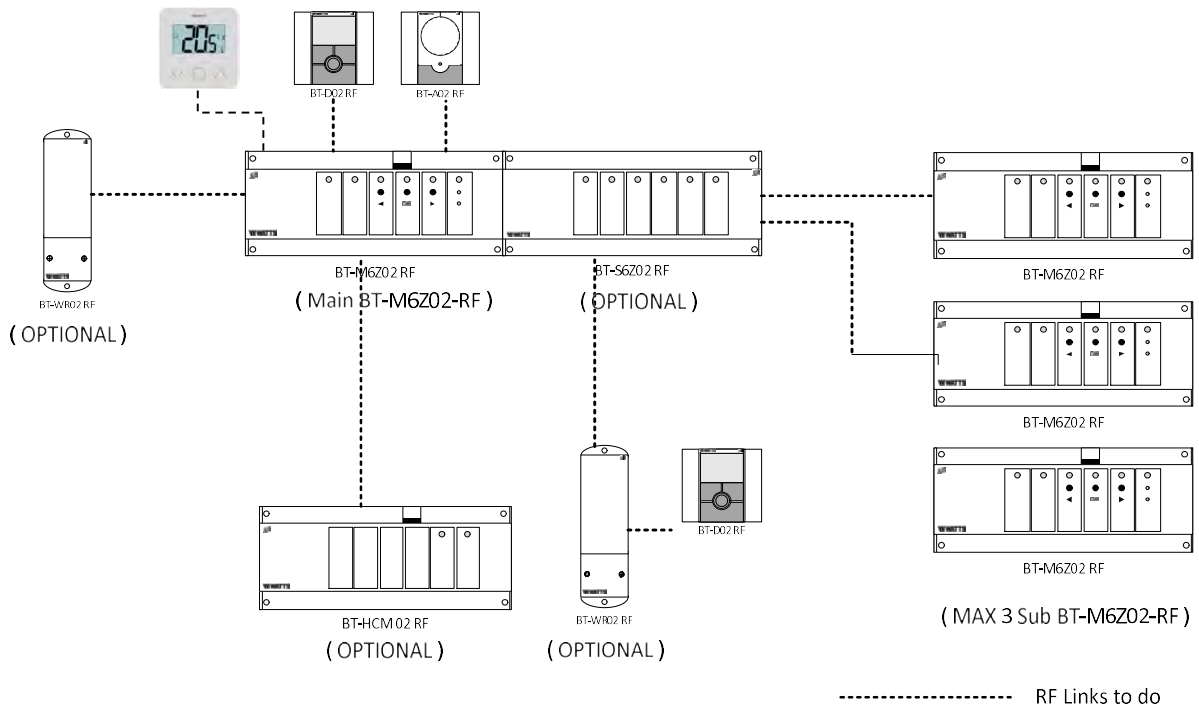

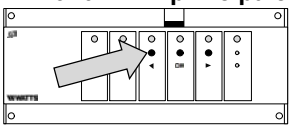
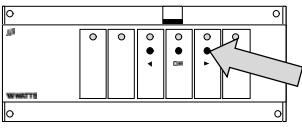
Elemento 1 da collegare	Elemento 2 da collegare	Commenti
<p>Effettuare la procedura di collegamento RF in versione autonoma, quindi procedere al collegamento RF di tutti i BT-M6Z02-RF.</p>		
<p>BT-M6Z02-RF "principale"</p>  <p>BT-M6Z02 RF</p> <p>Premere < per 5 secondi. Tutti i canali</p>	<p>BT-M6Z02-RF "subordinato"</p>  <p>BT-M6Z02 RF</p>	<p>Quando il collegamento è stato effettuato, i due BT-M6Z02-RF ritornano alla modalità Normale.</p>

devono diventare verdi. Il prodotto è in attesa del collegamento.
 Nota: per uscire, premere < per 5 secondi.

Premere > per 5 secondi.
 Tutti i canali devono diventare rossi. Il prodotto è in attesa del collegamento.
 Nota: per uscire, premere > per 5 secondi.

6.B. Impianto con controllore touchscreen BT-CT02-RF

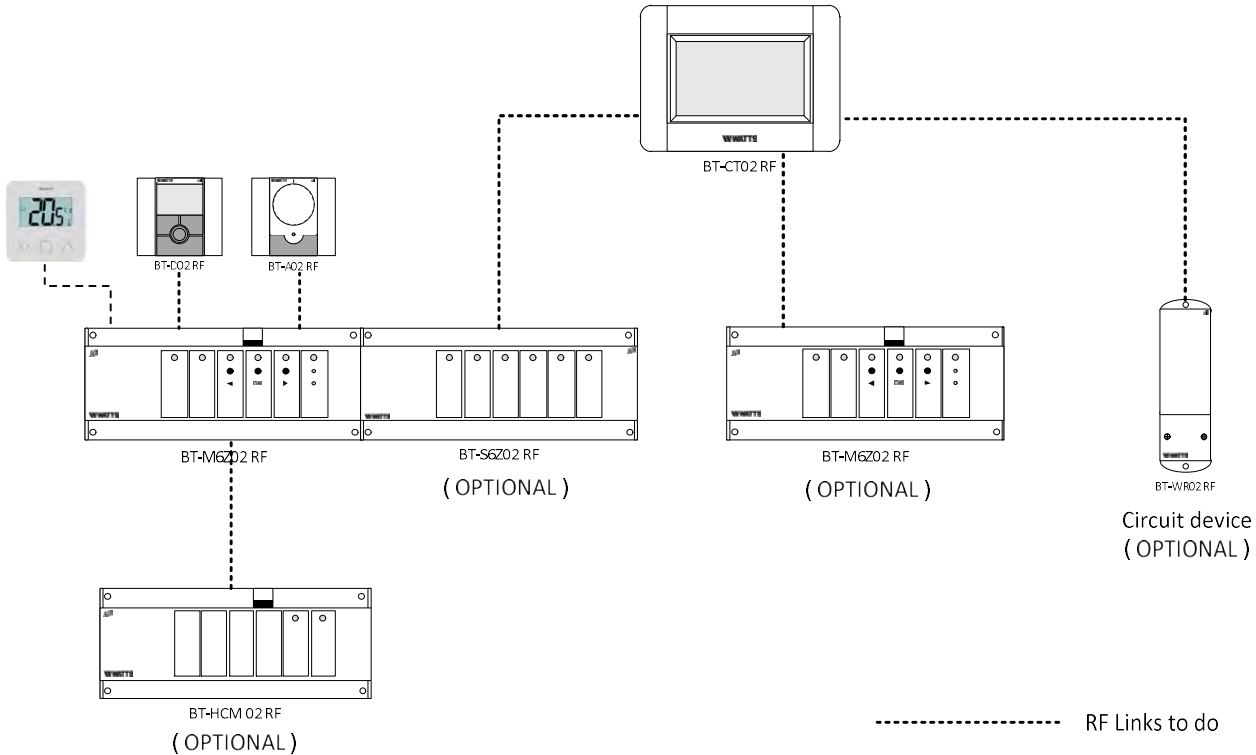

Se nell'impianto c'è un controllore touchscreen BT-CT02-RF, tutto verrà centralizzato su di esso.

Esempio di "impianto centralizzato"

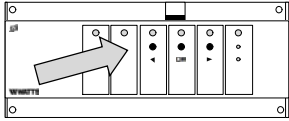
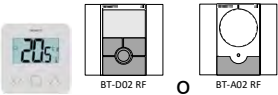

In questa configurazione, procedere al collegamento RF in quest'ordine:

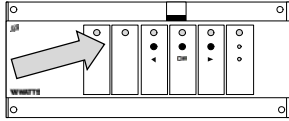
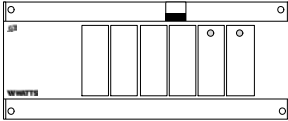
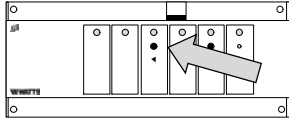
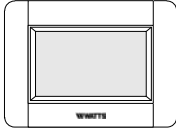
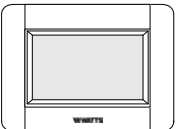
Elemento 1 da collegare	Elemento 2 da collegare	Commenti
<p style="text-align: center;">BT-M6Z02-RF</p>  <p style="text-align: center;">BT-M6Z02-RF</p> <p>Premere OK per 5 secondi. Il primo canale LED deve lampeggiare. Scegliere i canali con < e > e selezionare/deselezionare la zona con OK. Quando si seleziona una zona, questa diventa rossa. Nota: per uscire, premere OK per 5 secondi.</p>	<p style="text-align: center;">BT-D03 RF /BT-D(P)02-RF/BT-A02-RF</p>  <p>Termostati: Mettere il prodotto in modalità Collegamento RF (fare riferimento al relativo manuale di istruzioni).</p>	<p>Se è stato effettuato il collegamento, i LED dei canali selezionati sul BT-M6Z02 RF devono diventare verdi e i termostati devono uscire dalla modalità Collegamento.</p>

<p style="text-align: center;">BT-M6Z02-RF</p>  <p style="text-align: center;">BT-M6Z02 RF</p> <p>Premere < per 5 secondi. Tutti i canali devono diventare verdi. Il prodotto è in attesa del collegamento. Nota: per uscire, premere < per 5 secondi.</p>	<p style="text-align: center;">BT-HCM02-RF</p>  <p style="text-align: center;">BT-HCM 02 RF</p> <p>Mettere il prodotto in modalità Collegamento RF.</p>	<p>A collegamento effettuato, il BT-M6Z02-RF ed il BT-HCM02-RF ritornano alla modalità Normale.</p> <p>ATTENZIONE: solo un modulo BT-HCM02-RF per impianto</p>
<p style="text-align: center;">BT-M6Z02-RF</p>  <p style="text-align: center;">BT-M6Z02 RF</p> <p>Premere > per 5 secondi. Tutti i canali devono diventare rossi. Il prodotto è in attesa del collegamento. Nota: per uscire, premere > per 5 secondi.</p>	<p style="text-align: center;">BT-CT02-RF</p>  <p style="text-align: center;">BT-CT02 RF</p> <p>Collegamento come zona normale</p>	
<p style="text-align: center;">BT-CT02-RF</p>  <p style="text-align: center;">BT-CT02 RF</p> <p>Collegamento come dispositivo del "circuito"</p>	<p style="text-align: center;">BT-WR02-RF</p>  <p style="text-align: center;">BT-WR02 RF</p> <p>Mettere il prodotto in modalità Collegamento RF.</p>	<p>In questa configurazione, il BT-WR02-RF è usato come dispositivo del circuito idraulico: Fare riferimento al manuale di istruzioni del controllore BT-CT02-RF per ulteriori spiegazioni.</p>

Attenzione! Collegare il BT-M6Z02-RF al BT-CT02-RF solo dopo aver collegato TUTTI i termostati al modulo BT-M6Z02-RF.

7 FUNZIONI SPECIALI

Gestione dell'umidità

Questa funzione è disponibile sui termostati con sensore di umidità (BT-D02RF RH e BT-DP02RF RH).

Fare riferimento al manuale di istruzioni del termostato per impostare correttamente i parametri.

- Se c'è un valore predefinito di umidità (punto di rugiada o soglia di umidità), il raffreddamento nella zona viene arrestato, ovvero si arresta il passaggio di acqua nella zona.
- Se nell'impianto c'è un BT-HCM02-RF e il deumidificatore è attivo, in caso di valore anomalo di umidità, il deumidificatore si attiva.

Ritardo della pompa (non configurabile)

Per evitare danni alla pompa e rumorosità nel circuito idraulico (passaggio d'acqua nei tubi), l'avvio della pompa viene ritardato di 1 minuto dalla richiesta di riscaldamento dei termostati della zona. Questo ritardo permette all'attuatore di aprirsi completamente prima dell'attivazione della pompa.

Movimentazione della valvola (non configurabile)

Per evitare che le valvole si blocchino, ognuna di esse viene attivata automaticamente per 2 minuti alla settimana.

Funzione Impostazioni di fabbrica:

Usare questa funzione per cancellare tutte le configurazioni, i collegamenti RF e ripristinare le impostazioni di fabbrica.

In "modalità Funzionamento", premere contemporaneamente per 5 secondi i tasti (◀) e (▶). A questo punto il prodotto è stato resettato.

1 GUÍA DEL USUARIO

La caja de conexión BT-M6Z02-RF está diseñada específicamente para su sistema de calefacción y refrigeración por suelo radiante.

Puede gestionar actuadores normalmente cerrados y actuadores normalmente abiertos.

La caja de conexión cuenta con 6 actuadores de salida y esta cantidad puede ampliarse a 10 o 12 mediante una extensión.

BT-M6Z02-RF funciona con termostatos emparejados en RF; puede tener hasta 12 termostatos emparejados y gestionar 12 regulaciones independientes en paralelo.

Funciona con todos los termostatos de la gama BT02 RF / BT-03 RF.

BT-M6Z02-RF cuenta con las siguientes características especiales:

- Salida para bomba o caldera (con cable o inalámbrica con BT-WR02-RF)
- Gestión de humedad (a través de BT-D02-RF RH y BT-DP02-RF RH)
- Gestión de entrada de la señal de refrigeración y calefacción (a través de BT-HCM02-RF)
- Salida para deshumidificador (a través de BT-HCM02-RF)
- Conexión con la unidad central de BT-CT02-RF

2 CARACTERÍSTICAS TÉCNICAS

	BT-M6Z02-RF 230 V	BT-M6Z02-RF 24 V
Temperatura de funcionamiento	De 0 °C a 50 °C	
Características de regulación	Regulación integral proporcional o regulación por histéresis. La regulación está definida por el termostato emparejado al canal (consulte el manual del termostato).	
Tensión de alimentación	230 V CA, +- 10 %, 50 Hz	24 V CA, +- 10 %, 50 Hz
Salidas: Bomba o accesorios Actuadores	Relé => 5 A / 250 V CA (sin contacto) Relé => 5 A / 230 V CA (L, N) Para una instalación sencilla, recomendamos un máximo de 4 actuadores por zona.	Relé => 5 A / 250 V CA (sin contacto) Triac => 3 A / 24 V CA El número total de actuadores está limitado por el transformador (60 VA), el fusible (2,5 A) y la potencia de los actuadores.
Radiofrecuencia	868, 3 MHz, <10 mW. Alcance de aproximadamente 180 metros en un espacio abierto. Alcance de aproximadamente 50 metros en un entorno residencial.	
Declaración de conformidad UE Por la presente, Watts Electronics declara que este equipo cumple con la legislación relevante en materia de armonización comunitaria.	Directiva 2001/95/CE relativa a la seguridad general de los productos Directiva 2014/35/UE relativa a la adaptación de las legislaciones de los Estados miembros sobre el material eléctrico destinado a utilizarse con determinados límites de tensión Directiva 2014/53/UE relativa a la armonización de las legislaciones de los Estados miembros sobre la comercialización de equipos radioeléctricos Directiva 2011/65/UE sobre restricciones a la utilización de determinadas sustancias peligrosas en aparatos eléctricos y electrónicos Directiva 2014/30/UE relativa a la adaptación de las legislaciones de los Estados miembros en materia de compatibilidad electromagnética El texto completo de la declaración de conformidad UE está disponible en wattswater.eu.	
Protección	IP 30	
Compatibilidad	Con BT S4Z02 RF: 10 zonas => 1 dispositivo maestro de 6 zonas + 1 dispositivo esclavo de 4 zonas Con BT S6Z02 RF: 12 zonas => 1 dispositivo maestro de 6 zonas + 1 dispositivo esclavo de 6 zonas BT-WR02-RF BT-WR02 FC RF BT-PR02-RF BT-FR02-RF BT-CT02-RF Repetidor RF	

3 Interfaz de usuario



3.A. Significado de los colores de los ledes

En el dispositivo BT-M6Z02-RF hay un led de dos colores por zona (1) a (6) y dos ledes de estado adicionales.

En el modo de funcionamiento normal:

- (1) a (6):
 - o **Rojo fijo:** indicador de demanda de calefacción o refrigeración (circulación de agua en esta zona).
 - o **Verde parpadeante:** señal de RF recibida por parte del termostato asignado a esa zona.
 - o **Rojo parpadeante:** alarma de RF, se ha perdido la comunicación entre el termostato y el dispositivo BT-M6Z02-RF (en ese caso, compruebe las pilas del termostato).
 - o **Rojo parpadeante en todas las zonas:** compruebe la conexión de la antena de RF.
- (7): indicador de la bomba
 - o Es **verde** cuando la salida de la bomba está activa.
- (8): indicador de calefacción y refrigeración
 - o Es **verde** cuando está refrigerando.
 - o Es **rojo** cuando está calentando.
 - o Parpadeo rojo o verde: Alarma de RF entre el BT-M6Z02 RF y cualquier otro dispositivo que no sea un termostato

En el modo de emparejamiento de RF los indicadores led (1) a (6) tienen un significado distinto. Consulte 6.

3.B. Botones

En el dispositivo BT-M6Z02-RF, hay tres botones: «<», «OK» y «>».

Se utilizan para:

- conectar elementos a BT-M6Z02-RF: consulte el apartado 7
- restablecer los valores de fábrica (restablecer toda la configuración y los emparejamientos de RF): consulte el apartado 7

3.C. Configuración del interruptor DIP

Si desatornilla la parte delantera de BT-M6Z02-RF, tiene acceso a los cuatro interruptores que se utilizan para la configuración avanzada:

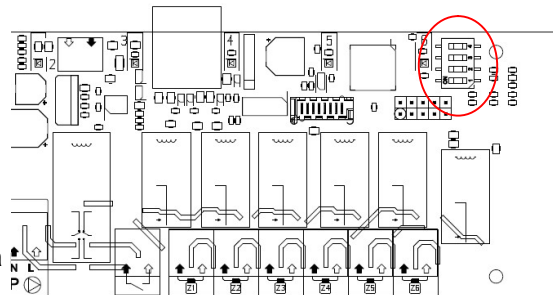

Los cuatro interruptores están desactivados de forma

Interruptor 1: configuración de la bomba local / global (salida de la bomba Y dispositivo de bomba remoto).

Activado (global): BT-M6Z02-RF activa su bomba si se produce una demanda de calefacción o refrigeración en el sistema.

Apagado (local): BT-M6Z02-RF activa su bomba solo si se produce una demanda en BT-M6Z02-RF.

Interruptor 2: configuración de NO / NC.

Activado (NO): las salidas (los actuadores) están normalmente abiertas.

Apagado (NC): las salidas (los actuadores) están normalmente cerradas.

Interruptor 3: configuración de la actividad de la bomba.

Activado: una vez por semana, la salida de la bomba se activa durante un minuto y, después, se cierra durante otro minuto.

Apagado: no se produce ninguna acción en la salida de la bomba.

Interruptor 4: no se produce ninguna acción.

4 DIAGRAMA DE MONTAJE DEL CABLEADO

4.1 DIAGRAMA DE MONTAJE DEL CABLEADO 230 V

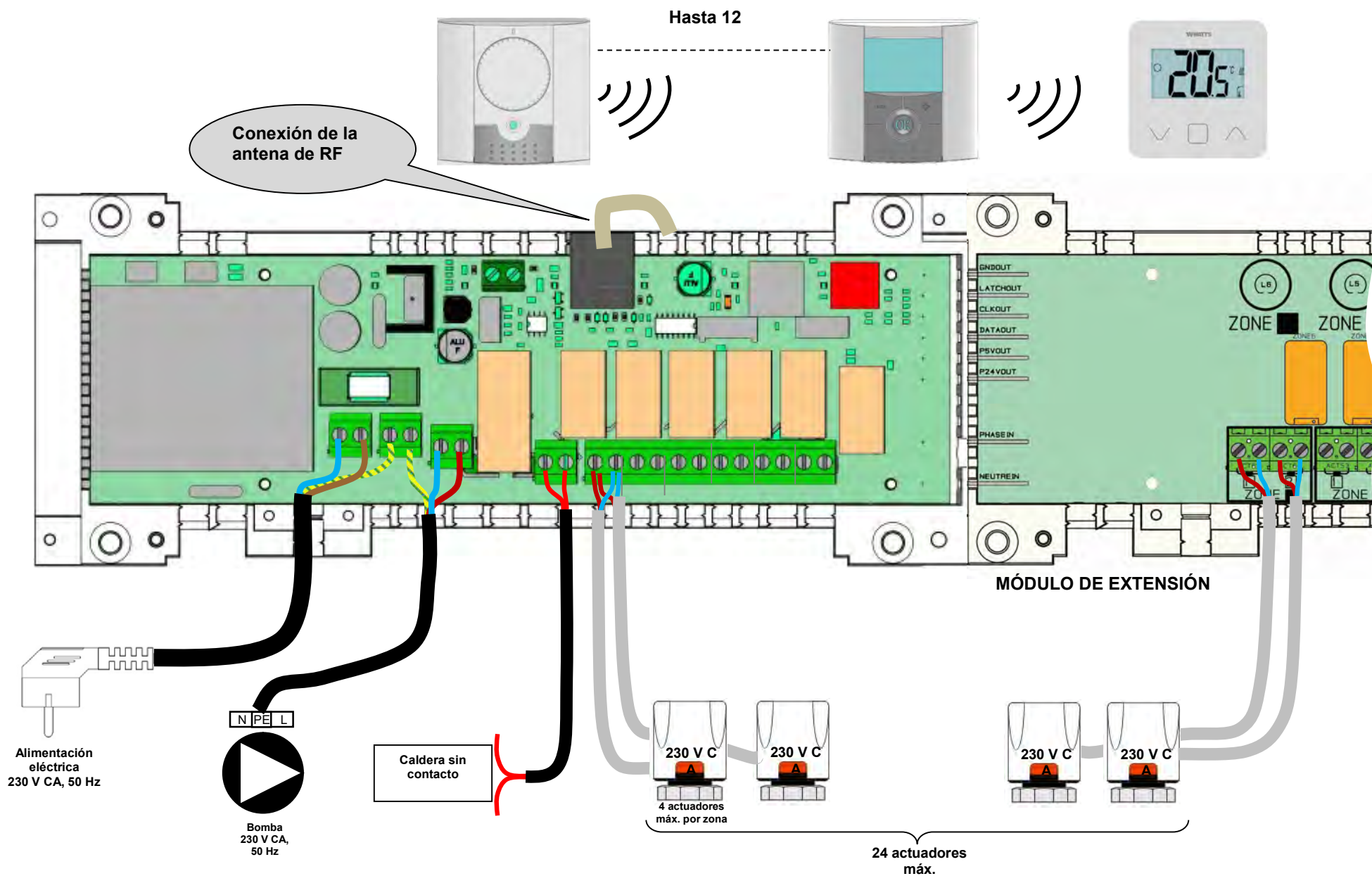

4.2 DIAGRAMA DE MONTAJE DEL CABLEADO 24 V

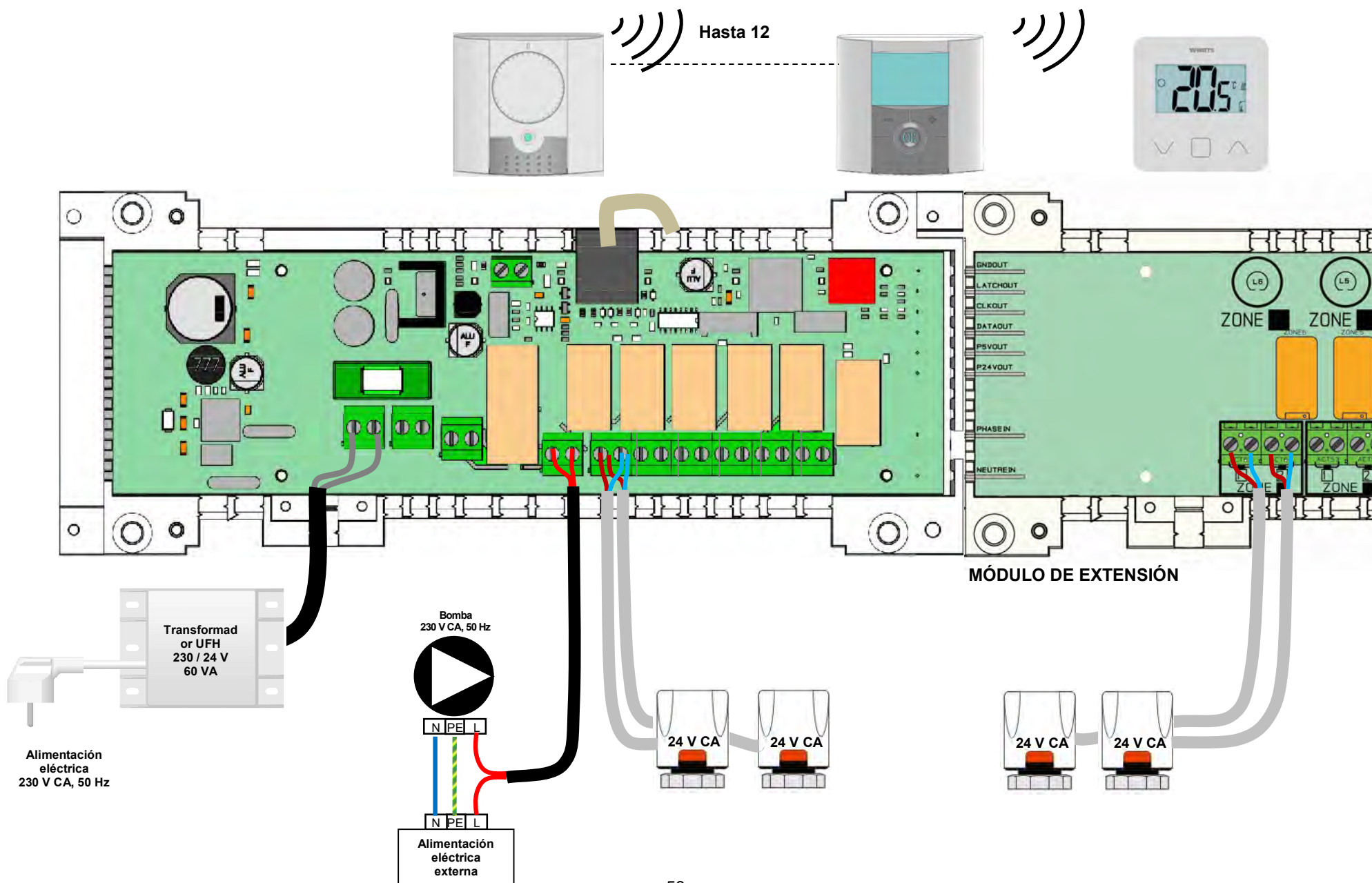

5 CÓMO INSTALAR CORRECTAMENTE SU SISTEMA RF

⚠ Respete las instrucciones de montaje para optimizar la sensibilidad y evitar cualquier funcionamiento incorrecto.

La antena debe colocarse:

- fuera de la caja metálica;
- en posición vertical
- y a 50 cm, mínimo, de piezas metálicas.

Si tiene varias antenas (varios dispositivos BT-M6Z02RF / BT-HCM02-RF en el mismo lugar), estas deben colocarse dejando una distancia mínima de 80 cm entre ellas.

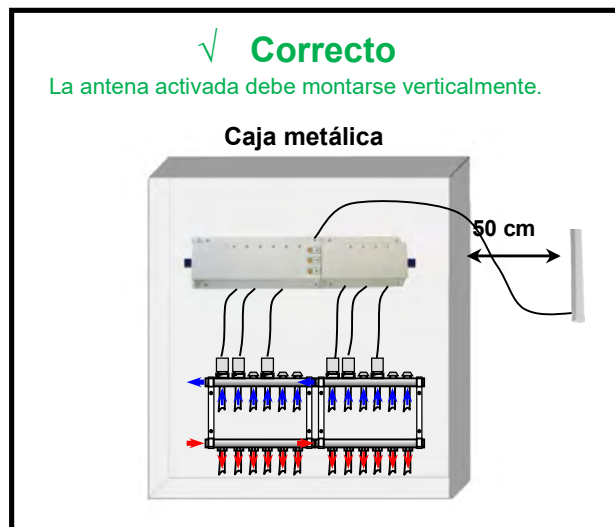

6 POSIBILIDADES DEL SISTEMA:

Consulte el manual de configuración del sistema (www.wattselectronics.com) para obtener más información sobre las distintas posibilidades.

Distinguimos entre dos tipos de instalación y si tiene un dispositivo BT-CT02-RF en su instalación, vaya al apartado 6.B.

6.A. Instalación de BT-CT02-RF sin pantalla táctil

En esta instalación, existen dos subcasos:

- 5- Instalación «independiente»: Instalaciones típicas:
 - a. Un único BT-M6Z02-RF
 - b. Varios BT-M6Z02-RF con gestión local de la bomba
- 6- Instalación con «gestión centralizada»: en este caso, hay varios BT-M6Z02-RF que necesitan comunicarse entre ellos para accionar correctamente la señal de calefacción / refrigeración de la palanca de la bomba.
 - a. Varios BT-M6Z02-RF con gestión global de la bomba
 - b. Al menos varios BT-M6Z02-RF y un BT-HCM02-RF

6.A.1 Instalación independiente. Ejemplo de una «instalación independiente»

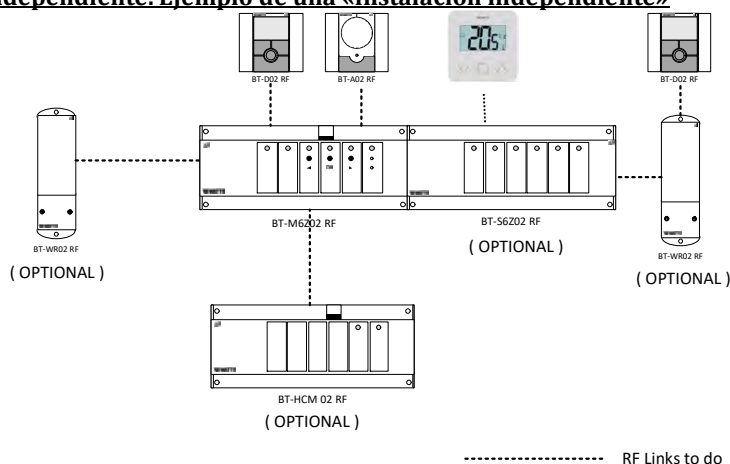

Todos esos elementos necesitan conectarse entre ellos y el procedimiento de emparejamiento de RF puede realizarse en este orden:

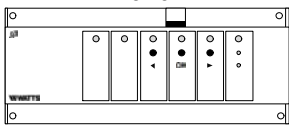
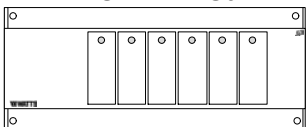
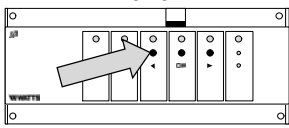
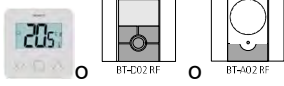
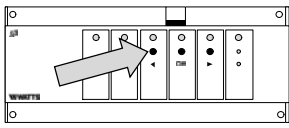
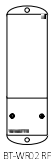
Elemento 1 a conectar	Elemento 2 a conectar	Observaciones
<p style="text-align: center;">BT-M6Z02-RF</p>  <p style="text-align: center;">BT-M6Z02 RF</p>	<p style="text-align: center;">BT-S4Z / BT-S6Z</p>  <p style="text-align: center;">BT-S6Z02 RF</p>	<p>No es preciso emparejarlos, solo hay que montar S4Z o S6Z en BT-M6Z02-RF (ambos productos están apagados) y puede seleccionar las zonas adicionales.</p>
<p style="text-align: center;">BT-M6Z02-RF</p>  <p style="text-align: center;">BT-M6Z02 RF</p> <p>Pulse el botón «OK» durante 5 segundos, el primer led de los canales debe parpadear. Seleccione los canales con los botones «<» y «>», después, marque o desmarque la zona con el botón «OK». Cuando una zona está seleccionada, el LED se vuelve rojo. Nota: para salir, pulse el botón «OK» durante 5 segundos.</p>	<p style="text-align: center;">BT-D03 RF / BT-D(P)02-RF / BT-A02-RF</p>  <p>Termostatos: Ponga el producto en el modo de emparejamiento de RF (consulte el manual de instrucciones correspondiente).</p>	<p>Si el emparejamiento ha terminado, los ledes de los canales seleccionados en BT-M6Z02 RF deben volverse verde y los termostatos deben salir del modo de emparejamiento de RF.</p>
<p style="text-align: center;">BT-M6Z02-RF</p>  <p style="text-align: center;">BT-M6Z02 RF</p> <p>Pulse el botón «<» durante 5 segundos, todos los ledes de los canales deben estar en verde y parpadear. El producto está esperando para ser conectado. Nota: para salir, pulse el botón «<» durante 5 segundos.</p>	<p style="text-align: center;">BT-WR02-RF</p>  <p style="text-align: center;">BT-WR02 RF</p> <p>Ponga el producto en el modo de emparejamiento de RF</p>	<p>En esta configuración, BT-WR02-RF se usa como en un dispositivo de bomba remoto o una caldera: si se produce una demanda en BT-M6Z02-RF, el dispositivo ordenará la salida. Una vez realizado el emparejamiento, BT-M6Z02-RF y BT-WR02-RF vuelven al modo normal. NOTA: también puede usar BT-FR02-RF y BT-PR02-RF en lugar de BT-WR02-RF.</p>

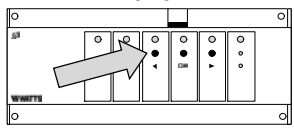
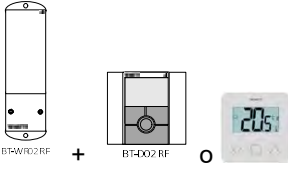
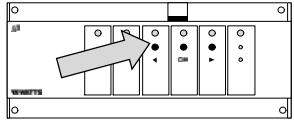
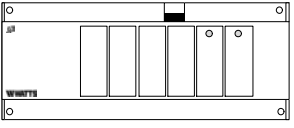
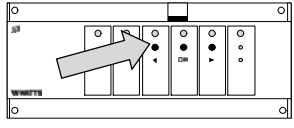
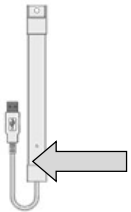
<p style="text-align: center;">BT-M6Z02-RF</p>  <p style="text-align: center;">BT-M6Z02 RF</p> <p>Pulse el botón «<» durante 5 segundos, todos los ledes de los canales deben estar en verde y parpadear. El producto está esperando para ser conectado. Nota: para salir, pulse el botón «>» durante 5 segundos.</p>	<p style="text-align: center;">BT-WR02-RF + BT-D02-RF / BT-D03 RF</p>  <p>BT-WR02-RF debe de haberse emparejado primero con el termostato. Ponga BT-WR02-RF en el modo de emparejamiento de RF.</p>	<p>En esta configuración, BT-WR02-RF se usa como una zona adicional. Una vez realizado el emparejamiento, BT-M6Z02-RF y BT-WR02-RF vuelven al modo normal. NOTA 1: también puede usar BT-FR02-RF y BT-PR02-RF en lugar de BT-WR02-RF. NOTA 2: esta configuración solo es posible en la instalación de la calefacción (no de la refrigeración).</p>
<p style="text-align: center;">BT-M6Z02-RF</p>  <p style="text-align: center;">BT-M6Z02 RF</p> <p>Pulse el botón «<» durante 5 segundos, todos los ledes de los canales deben estar en verde y parpadear. El producto está esperando para ser conectado. Nota: para salir, pulse el botón «>» durante 5 segundos.</p>	<p style="text-align: center;">BT-HCM02-RF</p>  <p style="text-align: center;">BT-HCM02 RF</p> <p>Ponga el producto en el modo de emparejamiento de RF</p>	<p>Una vez realizado el emparejamiento, BT-M6Z02-RF y BT-HCM02-RF vuelven al modo normal al mismo tiempo.</p>
<p style="text-align: center;">BT-M6Z02-RF</p>  <p style="text-align: center;">BT-M6Z02 RF</p> <p>Pulse el botón «<» durante 5 segundos, todos los ledes de los canales deben estar en verde y parpadear. El producto está esperando para ser conectado. Nota: para salir, pulse el botón «>» durante 5 segundos.</p>	<p style="text-align: center;">Repetidor RF</p>  <p>Ponga el repetidor RF en el modo de emparejamiento de RF (Pulse el botón durante más de 3 segundos)</p>	<p>Una vez realizado el emparejamiento, BT-M6Z02-RF vuelve al modo normal y el led de el repetidor quedará fijo en verde.</p>

6.A.2 Instalación centralizada

En esta configuración, una BT-M6Z02-RF (llamada BT-M6Z02-RF «principal») centralizará la información de la otra BT-M6Z02-RF (llamada BT-M6Z02-RF «secundaria»).

Su función es

- propagar la señal de calefacción y refrigeración en el sistema
- para gestionar la caldera / bomba global de todo el sistema.

Si hay una BT-HCM02-RF en la instalación, esta DEBE emparejarse con la BT-M6Z02-RF «principal».

Ejemplo de una «instalación centralizada»

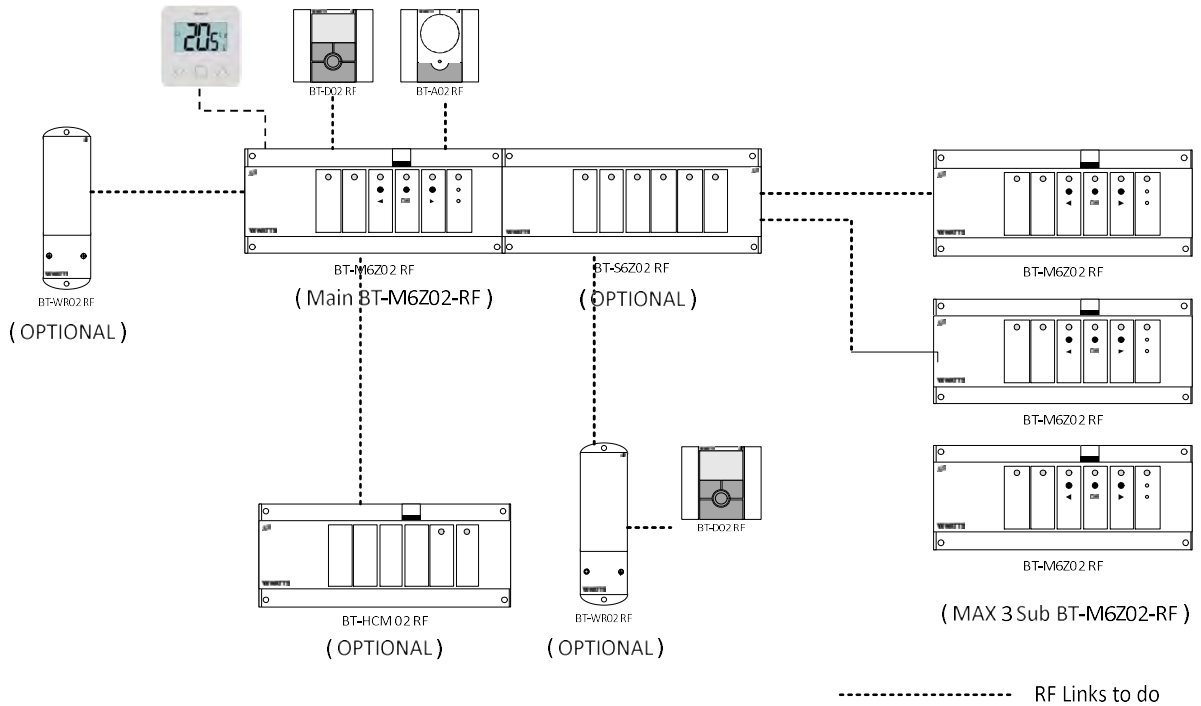

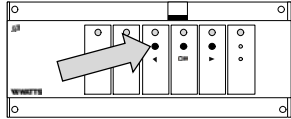
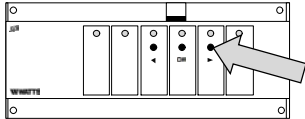
Elemento 1 a conectar	Elemento 2 a conectar	Observaciones
<p>Lleve a cabo el procedimiento de emparejamiento de RF como en la versión independiente y, a continuación, realice el emparejamiento de RF de todas las BT-M6Z02-RF.</p>		
<p>BT-M6Z02-RF «principal»</p>  <p style="text-align: center;">BT-M6Z02 RF</p> <p>Pulse el botón «<>» durante 5 segundos, todos los ledes de los canales deben estar en verde y parpadear. El producto está esperando para ser conectado. Nota: para salir, pulse el botón «<>» durante 5 segundos.</p>	<p>BT-M6Z02-RF «secundaria»</p>  <p style="text-align: center;">BT-M6Z02 RF</p> <p>Pulse el botón «>>» durante 5 segundos, todos los ledes de los canales deben estar en rojo y parpadear. El producto está esperando para ser conectado. Nota: para salir, pulse el botón «>>» durante 5 segundos.</p>	<p>Una vez terminado el emparejamiento, las dos BT-M6Z02-RF volverán al modo normal.</p>

6.B. Instalación de BT-CT02-RF con pantalla táctil

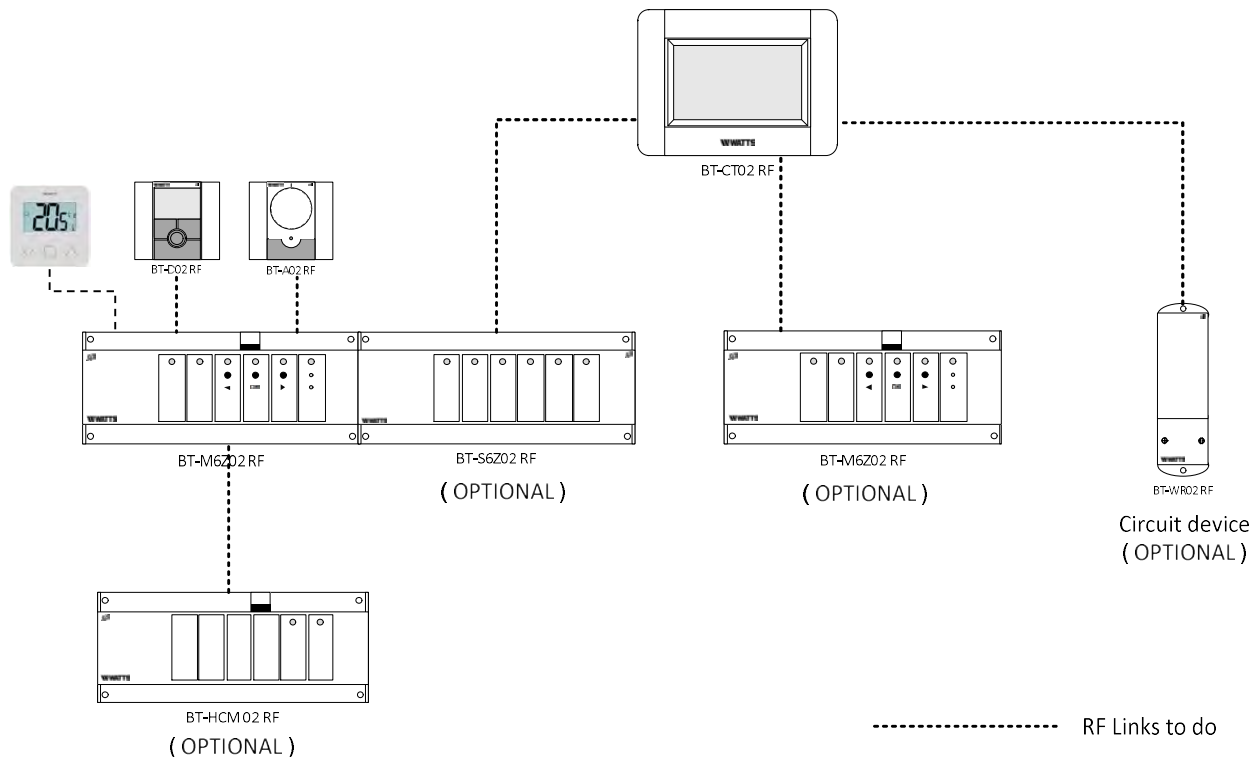

Si la instalación cuenta con una BT-CT02-RF con pantalla táctil, todo está centralizado en la pantalla táctil.

Ejemplo de una «instalación centralizada»

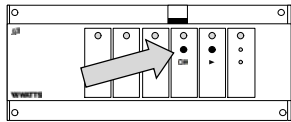
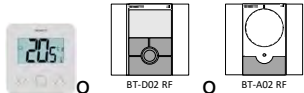
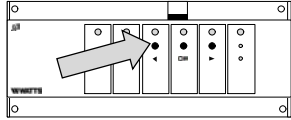
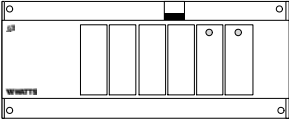

En esta configuración, realice el emparejamiento de RF en este orden:

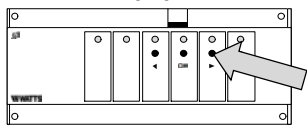
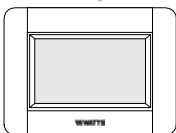
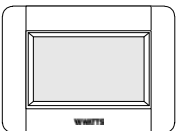
Elemento 1 a conectar	Elemento 2 a conectar	Observaciones
<p style="text-align: center;">BT-M6Z02-RF</p>  <p style="text-align: center;">BT-M6Z02 RF</p> <p>Pulse el botón «OK» durante 5 segundos, el primer led de los canales debe parpadear. Seleccione los canales con los botones «<» y «>», después, marque o desmarque la zona con el botón «OK». Cuando una zona está seleccionada, el LED se vuelve rojo. Nota: para salir, pulse el botón «OK» durante 5 segundos.</p>	<p>BT-D03 RF / BT-D(P)02-RF / BT-A02-RF</p>  <p>Termostatos: Ponga el producto en el modo de emparejamiento de RF (consulte el manual de instrucciones correspondiente).</p>	<p>Si el emparejamiento ha terminado, los ledes de los canales seleccionados en BT-M6Z02 RF deben volverse verde y los termostatos deben salir del modo de emparejamiento.</p>
<p style="text-align: center;">BT-M6Z02-RF</p>  <p style="text-align: center;">BT-M6Z02 RF</p> <p>Pulse el botón «<» durante 5 segundos, todos los ledes de los canales deben estar en verde y parpadear. El producto está esperando para ser conectado. Nota: para salir, pulse el botón «<» durante 5 segundos.</p>	<p style="text-align: center;">BT-HCM02-RF</p>  <p style="text-align: center;">BT-HCM02 RF</p> <p>Ponga el producto en el modo de emparejamiento de RF</p>	<p>Una vez realizado el emparejamiento, BT-M6Z02-RF y BT-HCM02-RF vuelven al modo normal.</p> <p>NOTA: solo hay una BT-HCM02-RF en la instalación.</p>

<p style="text-align: center;">BT-M6Z02-RF</p>  <p style="text-align: center;">BT-M6Z02 RF</p> <p>Pulse el botón «>» durante 5 segundos, todos los ledes de los canales deben estar en tojo y parpadear. El producto está esperando para ser conectado. Nota: para salir, pulse el botón «>» durante 5 segundos.</p>	<p style="text-align: center;">BT-CT02-RF</p>  <p style="text-align: center;">BT-CT02 RF</p> <p>Se empareja como una zona normal</p>	
<p style="text-align: center;">BT-CT02-RF</p>  <p style="text-align: center;">BT-CT02 RF</p> <p>Empareja el dispositivo de «circuito»</p>	<p style="text-align: center;">BT-WR02-RF</p>  <p style="text-align: center;">BT-WR02 RF</p> <p>Ponga el producto en el modo de emparejamiento de RF</p>	<p>En esta configuración, BT-WR02-RF se usa como dispositivo de circuito hidráulico: Consulte el manual de instrucciones de BT-CT02-RF para obtener más información.</p>

Atención: empareje BT-M6Z02-RF a BT-CT02-RF una vez que **TODOS** los termostatos hayan sido emparejados a BT-M6Z02-RF.

7 FUNCIONES ESPECIALES

Gestión de la humedad

Esta característica está disponible en los termostatos con sensor de humedad (BT-D02RF RH y BT-DP02RF RH). Consulte el manual de instrucciones del termostato para ajustar correctamente los parámetros.

- Si hay una falta de humedad (punto de condensación o límite de humedad), se detendrá la refrigeración de la zona (el flujo de la zona se detiene).
- Cuando en la instalación hay un BT-HCM02-RF y el deshumidificador está activado, si hay una falta de humedad, el deshumidificador estará activado.

Retardo de la bomba (no se puede configurar)

Para evitar daños en la bomba y ruido en el circuito hidráulico (flujo de agua en la tubería), la bomba tardará 1 minuto en ponerse en marcha tras producirse una demanda de los termostatos de la zona. Este retardo permite que el actuador se abra completamente antes de la activación de la bomba.

Actividad de la válvula (no se puede configurar)

Para evitar el agarrotamiento de las válvulas, cada válvula se activa automáticamente 2 minutos por semana.

Función de la configuración de fábrica:

Utilice esta función para borrar todas las configuraciones, así como todos los emparejamientos de RF y restablecer la configuración de fábrica.

En el «modo de ejecución», pulse las dos teclas (◀) y (▶) a la vez durante 5 segundos.

Después, el producto se habrá restablecido.

8 Información sobre eliminación y reciclaje



Eliminación correcta de este producto: el marcado que figura en el producto indica que no se debe eliminar junto con el resto de los residuos domésticos al final de su vida útil.

Este dispositivo puede ser utilizado por niños a partir de los 8 años, así como por personas con una discapacidad física, sensorial o mental, o por personas sin experiencia o conocimientos, siempre que lo hagan bajo una supervisión adecuada, o si han recibido instrucciones acerca del uso seguro del dispositivo e información acerca de los riesgos que puede entrañar su uso. Los niños no deben jugar con el dispositivo. La limpieza y el mantenimiento del producto son operaciones que no deben ser realizadas por niños sin supervisión.

